

OPERATING MANUAL

ITDSP-0404D

ITDSP-0808D

ITDSP-1208D

ITDSP-1616D

ITDSP-0404Dv2

ITDSP-0808Dv2

ITDSP-1616Dv2

Digital Sound Processor



WWW.INTREND-AV.RU

Help File

1. Technology Overview	5
1.1 Introduction to Technology	5
1.2 Audio Input Section.....	5
1.3 Audio Output Section.....	6
1.4 Float Point DSP	7
1.5 Audio Flow.....	9
1.6 Typical System Application	10
2. Hardware	12
2.1 Safety Instructions	12
2.2 Audio Wiring Reference.....	13
2.3 Specifications	15
2.4 Mechanical Data.....	16
2.5 Front Panel.....	16
2.6 Rear Panel	17
3. Software.....	18
3.1 Software Installation	18
3.2 Using the Software	19
3.3 Custom edit processing module.....	20
3.4 Audio Module Parameters.....	20
3.4.1 Input Source.....	21
3.4.2 Expander	22

3.4.3 Compressor & Limiter	23
3.4.4 Auto Gain Control	25
3.4.5 Equalizers	26
3.4.6 Figure Balancer	28
3.4.7 Feedback Inhibition	28
3.4.8 Noise Gate	31
3.4.9 Ducker.....	32
3.4.10 Spl.....	33
3.4.11AutoMixer.....	33
3.4.12Echo Cancellor	37
3.4.13Noise Suppression	37
3.4.14 Matrix	38
3.4.15 High & Low Pass Filter	38
3.4.16 Delayer	39
3.4.17 Output.....	39
3.4.19 USB Soundcard	41
3.5 Setting Menu.....	43
3.5.1 File Menu	43
3.5.2 Device Setting.....	44
3.5.3 GPIO Setting	44
3.5.4 Group Setting	47
3.5.5 Panel Setting.....	48
3.5.6 Dante Setting.....	51
3.5.7Help Menu	55

4. Dante Audio	56
4.1 Dante Overview	56
4.2 Dante Requirements	58
4.3 Dante Network Design	58
4.4 Dante Modes.....	60
4.5 Dante Controller.....	61
4.6 Dante Virtual Soundcard.....	61
5. Control	63
5.1 External Control Programmer.....	63
5.2 Control Protocol.....	63
5.3 Serial Port-to-UDP (RS232 To UDP).....	67
5.4 ASCII control command	68
6. FAQs	73
Appendix A: Module ID Distribution.....	74
Appendix B: Module Parameter Types (1)	75

1. Technology Overview

1.1 Introduction to Technology

DSP Series are equipped with several core technical features to facilitate the work of audio engineers. DSP-based remote audio hardware is routed, processed and controlled via computer. This Manual mainly introduces the techniques used to achieve the goal.

DSP Controller is a Windows-based application, which is used to conduct configuration and control on DSP hardware. DSP Controller has 16 built-in presets, and the modules and sequences for each preset can be flexibly designed in accordance with the designer's requirements. After the design is finished, it can be saved for future use. The sequences and parameters of DSP Controller's built-in processing modules accord to most of the application scenarios without any change.

DSP Controller is a full-featured application including the parameter adjustment and peripheral accessory settings of all modules, such as RS232, RS485, click-and-drag panel configuration and Dante network audio control etc. The most interesting part is the user interface, which allows the engineer to customize user interface so that the integrator can edit it or the onsite technicians or end users who have no idea of relevant techniques can operate it. Superior safety functions make it possible for the end users to access to the controls allowed by the engineer or designer.

1.2 Audio Input Section

DSP supports up to 16 fixed analog audio inputs, which can be connected via removable balanced phoenix connectors. The analog input section supports microphone or line-level signals whose nominal levels are 0dBu, 10dBu, 20dBu, 30dBu, 40dBu and 43dBu. +48VDC phantom power can be adopted for each input.



Preamp gain and phantom power can be conveniently controlled via DSP Controller.



A/D Technical Indicators:

Sampling rate: 48kHz

THD+N: $\leq 0.001\%$ @4dBu (A-weighting)

Dynamic range: 110dB

Audio format: 24Bit MSB TDM

1.3 Audio Output Section

Phase 1 of analog output section refers to D/A converter (DAC). DSP adopts advanced 24-bit 256X sampling converter. Just like A/D converter, it also uses multi-bit architecture for broader dynamic range; in the meantime, it is also equipped with excellent distortion just like regular digital unit analog converter. Unit gain (0dB) is set via volume control, and the analog output section is corrected as +4dBu with 20dB headroom. That is to say, 0dBFS digital signal is equivalent to +24dBu output signal. If other signal levels are required, you may change the volume to achieve it.

D/A Technical Indicators:

Sampling rate: 48kHz

THD+N: $\leq 0.001\%$ @4dBu (A-weighting)

Dynamic range (A-weighted): 112dB

Audio format: 24Bit MSB TDM

1.4 Float Point DSP

DSP device adopts analog device SHARC DSP, enabling 32-bit and 40-bit floating-point processing, which can be compared to 40-bit floating-point processing of other devices. Floating-point processing provides prominent advantages for the users in terms of sound quality and usability.

Fixed-Point Processing Limitations

Fixed-point processing has its own disadvantages. If there is a significant change in gain, data loss or more severe situation may occur, including clipping distortion. For example, for the processing of 24-bit fixed point-based audio signal, in some cases, if you attenuate the signal to 42dB, the new signal only includes 17-bit information. Due to gain attenuation, 7-bit information will get lost forever. More worse is the clipping distortion. For a signal nearly close to 0dBFS, the signal will be clipped at 0dBFS and the audio distortion will occur. Even if the signal level is adjusted to below 0dBFS through post-regulation, the clipping has occurred, and the distortion still exists. Fixed point processing can help to create some headroom above 0dBFS. By doing so, some bits have to be abandoned. For example, if a 12dB (2 bits) headroom is created, a 24-bit system actually only has 22 bits.

Floating-Point Processing

In the contrary, by taking advantage of floating-point processing, no matter what the signal level is, all available bits are uniformly distributed to the signals. Basically, the floating points use some bits as indexes to set up general signal level and distribute the remaining bits to signals with independently stored level. As a result, no matter what kind of level (from -200dB and 200dB below to 0dBFS above, the stored signal's accuracy is optimized without clipping distortion. SHARC provides 32-bit and 40-bit accurate processing; through 32-bit processing, 25 bits are distributed to storage signals no matter what its signal level is. This means that, based on at least 1-bit low level signal, its accuracy is always significantly superior to 24-bit fixed point processing. Through expanded 40-bit accurate processing, 33-bit storage signal can be achieved.

Practical Significance

What's the practical significance of floating point processing for the users? The gain stages between multiple modules can be ignored. If the signal level of a module is reduced by 50dB and is then restored to its original value through another processing, data loss will not occur. In the fixed-point system, the users must check other signal levels before sending it to A/D converter because all digital-to-analog converters adopt fixed points. In DSP system, if you

notice that your signal has been clipped before it is outputted and transmitted to the digital-to-analog converter, you may close it off immediately at the output section to correct the situation. By using the fixed point system, you have to search each processing module to find the clipping source.

1.5 Audio Flow

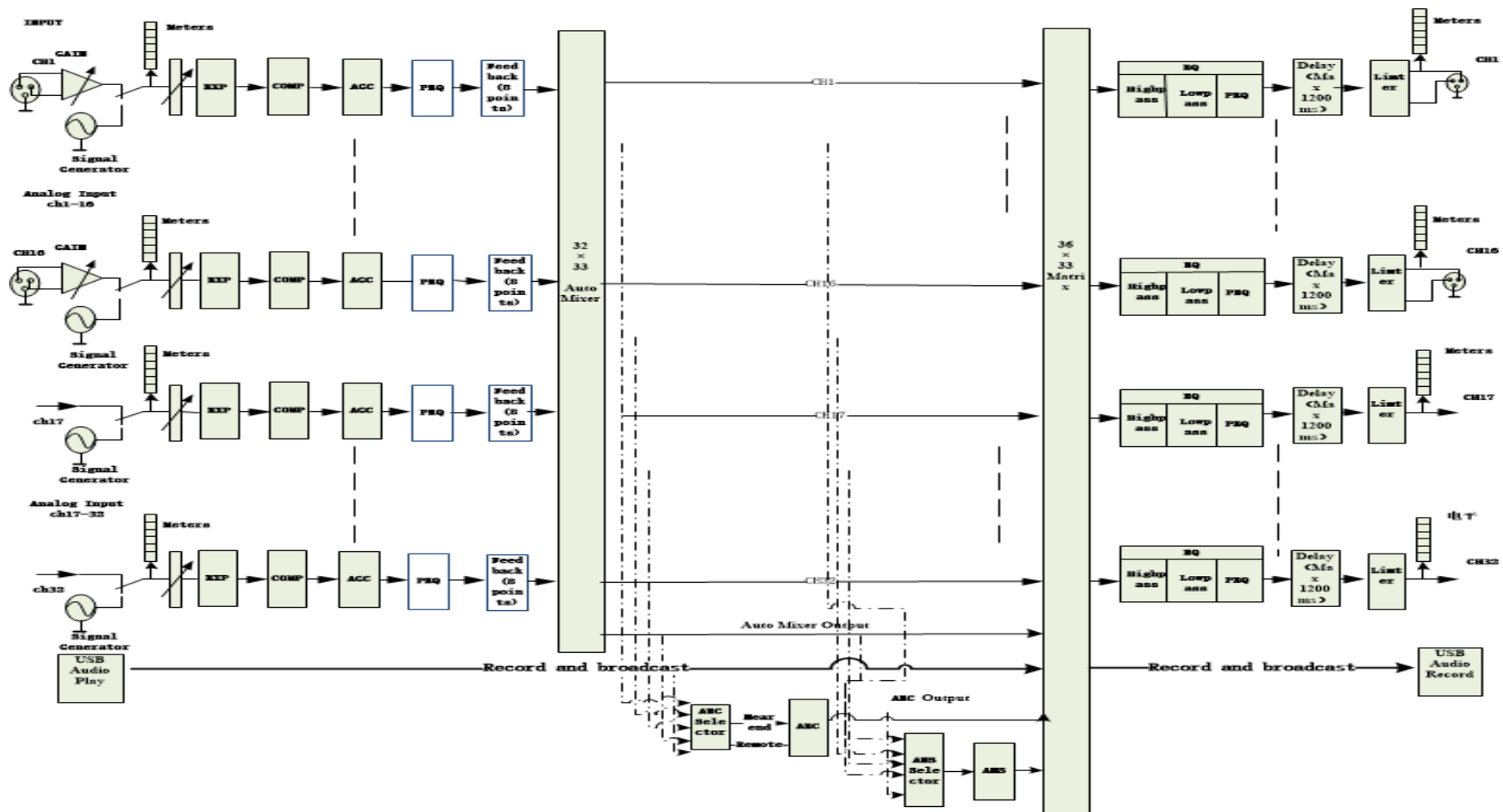

1.6 Typical System Application

Conference Amplifying System: The processor can be connected to capacitor microphone, local output amplifier and speaker so as to decorate and process with the signals via the speaker on output channel. The output signal can also transmitted to the recording device with Dante interface via such interface, such as computers with Dante virtual soundcard. By adopting a simple control panel, volume adjustment, scenario call and other functions can be achieved via UDP control processor.

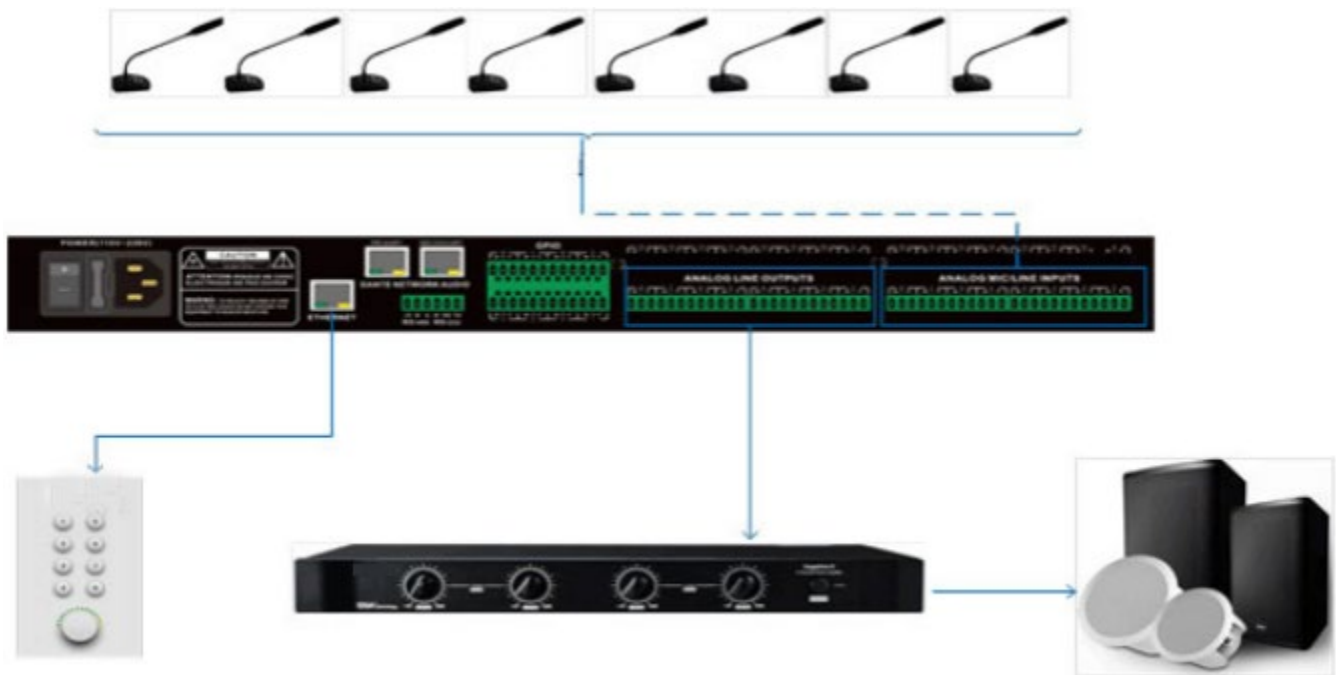

Dante Application: Dante network breaks through space limitations, and has a wide range of application scenarios. It can connect all devices that support Dante protocol to the same local area network. By cascading 2 DSPs, it supports the access of up to 32 analog microphones and 32 Dante microphones. Each processor will conduct first-level auto mixing on its own microphones, and the second-level auto mixing is then made on the mixed signal via the auto mixer of main processor so that more microphones can be connected to build a larger auto mixing matrix. The two-level auto mixing working mode can satisfy general application scenarios.

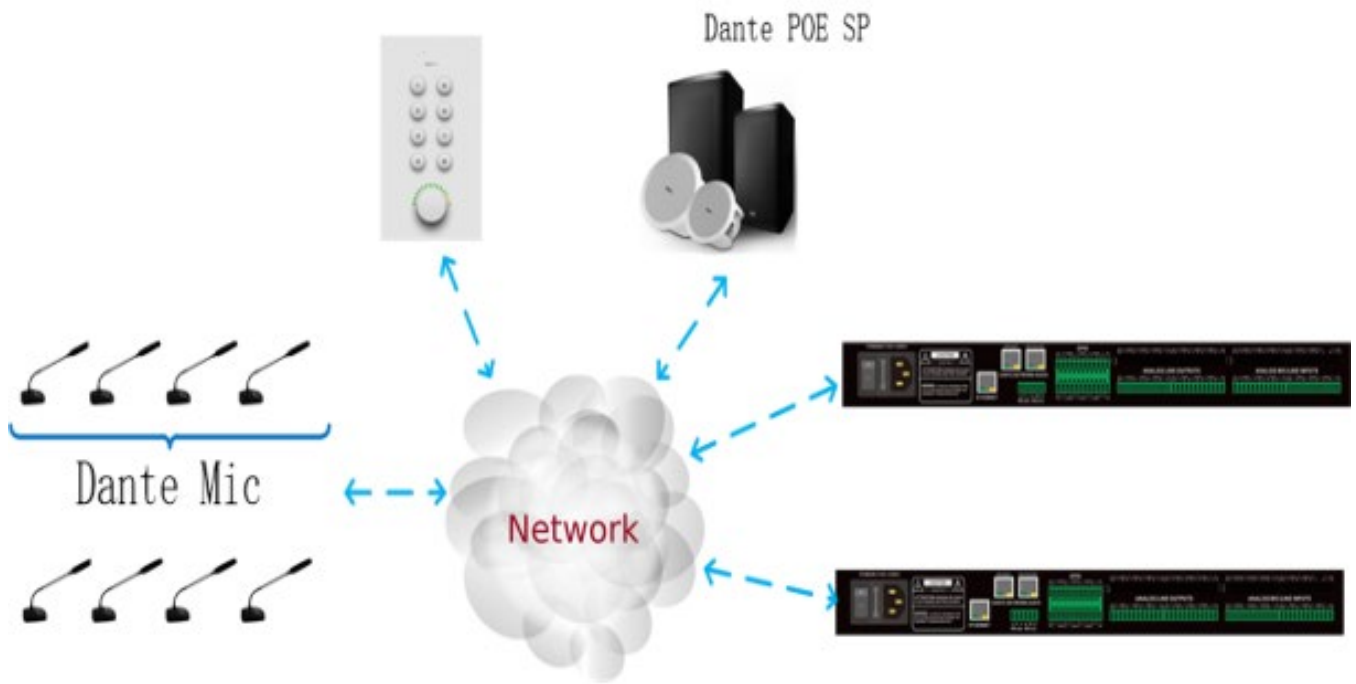

2. Hardware

2.1 Safety Instructions

Safety Instructions

Important safety instructions:

1. Read these instructions.
2. Keep these instructions well.
3. Pay attention to all warnings.
4. Follow all instructions.
5. Please keep the device away from water. The device shall not be exposed to water drips or water splashes; make sure that there is no object with liquid near the device, such as vase.
6. Please use dry cloth to clean up the device.
7. Please do not block the vent. Please get the device installed based on the manufacturer's instructions.
8. Please do not install any heat source, such as radiator, heat register, furnace or other devices (including amplifiers) that generate heat.
9. Please adopt protective grounding connection to connect the device to the power socket. Please do not use polarized plug or grounding plug. A polarized plug has two leaves, and one is wider than another. A grounding plug has two leaves and a third ground terminal. The wide leaf or third ground terminal can provide safety for the users. If the plug provided does not accord to the power socket, please contact the electrician to replace the old socket with a new one.
10. Protect the power cord so that it will not be tramped or protruded, especially the plug, the socket and the connections of cord and device.
11. Please use the accessories designated by the manufacturer.
12. Please only use the cart, the tripod, the holder or the desk designated by the manufacturer or sold together with the device. When using the cart, please take care with the mobile cart/device to avoid injury from rollover.
13. Please unplug the device during a thunderstorm or during the idle period.

14. Please find qualified maintenance personnel to deal with all maintenance problems. When the device gets damaged in any manner, the maintenance is required. For example, the power cord gets damaged, the liquid will spill over or the object falls into the device; the device is exposed to the rainwater or moisture; the operations are not correct, or the device falls off.

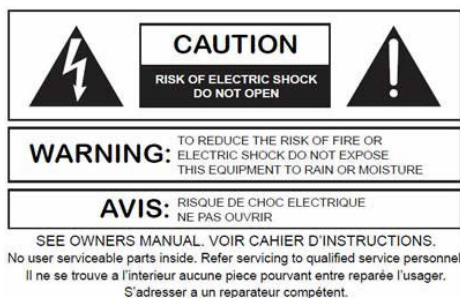

The lightning logo (an equilateral triangle with an arrow) is used to make the users aware of the uninsulated "dangerous voltage" within the product shell, which may cause electric shock. An equilateral triangle with an exclamation mark is adopted to make the users understand the importance of the operations and maintenance instructions given in the appendixes attached to the product.

Warning: In order to prevent electric shock, please do not use a polarized plug provided by a device with an extension cord. The socket outlet cannot be inserted except for sharp end.

2.2 Audio Wiring Reference

Balanced Connection

Any of these interfaces may occur on both sides of the connection.

Note: For one XLR interface, the female connects to the output device and the male connects to the input device.

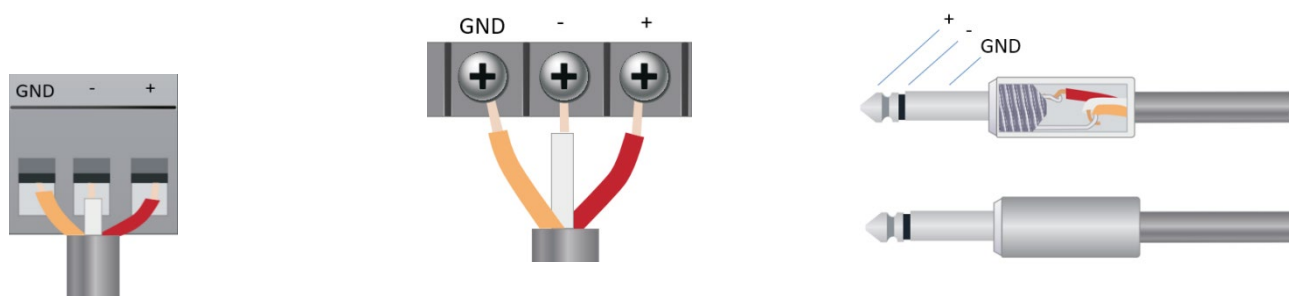

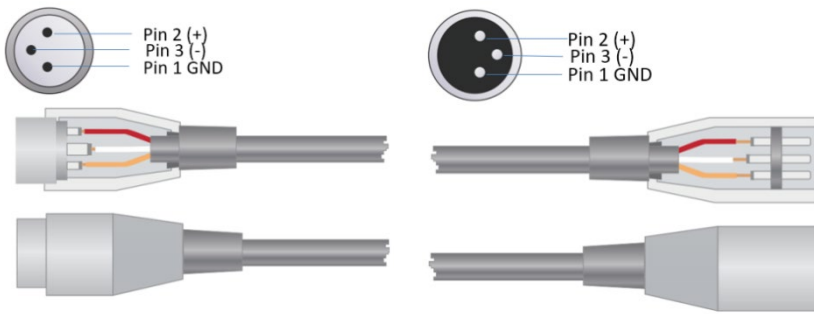

Unbalanced Connection

RCA interface and 1/4-inch TS interface are unbalanced interfaces. A multi-strand shielding conductor may be installed on both ends of unbalanced connection.

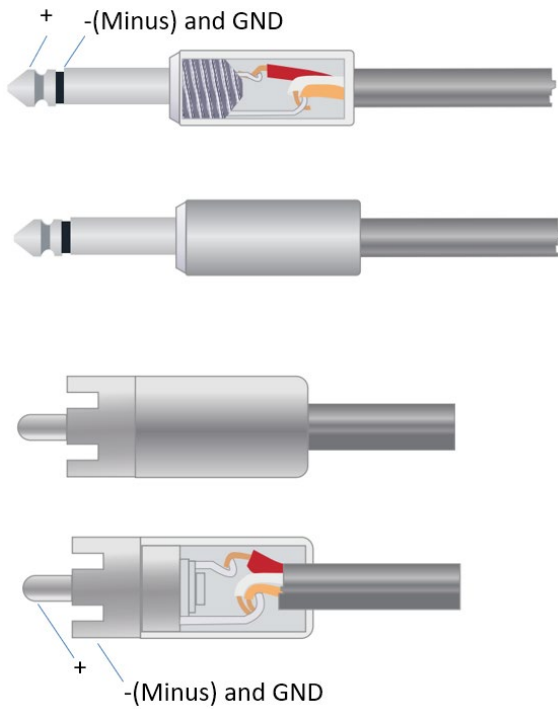

2.3 Specifications

Take 16x16 as an example (including Dante).

Processor	ADI SHARC 21489(x2)
Sampling rate/Digitalizing bit	48K/24bit
Input Gain	0/3/6/9/12/15/18/21/24/27/30/33/36/39/42/45/ 48 dBu
Phantom Power	48V
Frequency Response (20~20KHz)	±0.2dB
Maximum Level	+18dBu
THD + Noise	0.001%@4dBu
Dynamic Range	110 dB
Background Noise (A-weighted)	-91 Db
Common Mode Rejection Ratio @60Hz	80dB
Channel Isolation @1KHz	108 dB
Input Impedance (Balanced Connection)	9.4KΩ
Input Impedance (Balanced Connection)	102Ω
System Delay	<3ms
Working Power	AC110~240V 5Hz-60Hz
Maximum Power Consumption	<40W
Dimensions (Width x Depth x Height)	482 x 260 x 45mm
Shipping Weight	3KG

2.4 Mechanical Data

Space required:

1U (width * depth * height: 18.91" x 9.5"x 1.72" / 48.02 cm x 24.13 cm x 4.37 cm). The reserved head space is not included in the depth.

An additional space at least 3 inches shall be reserved for the connection of rear panel. The reserved depth depends on the wire used and the connection mode.

Electrical Property:

Maximum universal input power: 110-240 VAC, 50/60 Hz, 40 W.

Ventilation:

The recommended highest operating ambient temperature is 30°C / 86°F.

Make sure that there is no blockage on both sides (a gap (at least 5.08cm, 2 inches) shall be reserved). Please do not cover the thermovent of the device with newspapers, table cloth, curtain and other objects.

Shipping Weight:

6.6 lbs. (3 kg)

2.5 Front Panel

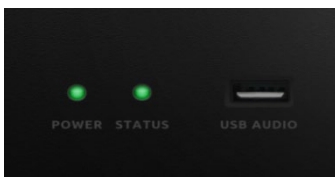

Power: LED power indicator;

STATUS: The operation status indicator of the device;

USB AUDIO: USB soundcard (1-in-1-out), which can be used to achieve recording function.

2.6 Rear Panel

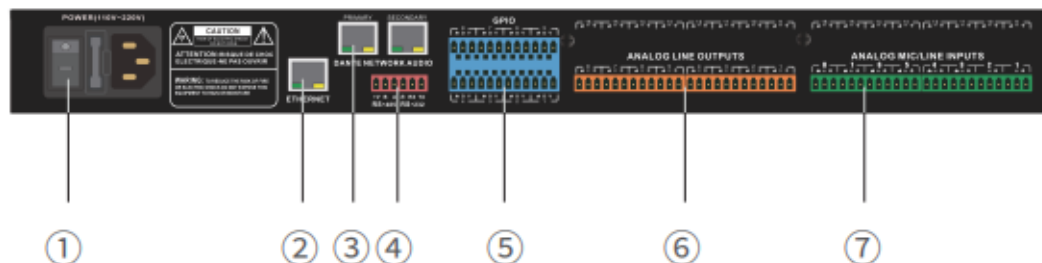

- ① POWER power interface: connect to 110V- 240V AC power supply, and the rocker switch controls the power supply of the processor.
- ② ETHERNET network control interface: By connecting this network port, the client computer can debug and monitor the equipment.
- ③ Dante network interface: used to connect Dante audio network.
- ④ RS232+RS485 interface: connect to the control terminal or central control equipment.
- ⑤ GPIO interface: Eight definable input/output logic level control ports, driven by the control module in the device design. It can be set in the software to meet the output level (0V or 5V) after internal conditions trigger; Or input level triggering (0V or 5V) to control corresponding internal functions.
- ⑥ OUTPUT analog signal output interface: can be connected to power amplifiers, active speakers and other equipment.
- ⑦ INPUT analog signal input interface: can connect microphone, DVD and other devices.

3. Software

3.1 Software Installation

A Windows PC with a 1 GHz or higher processor and:

Windows 7 or later.

1 GB of free storage space.

1024 x 768 resolution.



24-bit or higher color.

2 GB or more of memory.

Network (Ethernet) interface.

CAT5 cable or existing Ethernet network

The audio processor has built-in control software, which can be downloaded quickly by accessing the IP address of the audio processor. Enter the IP address of the device in the browser address bar to access the audio processor, find the download link and download the installation software to the local to complete the installation. The factory default IP address of the device is: 169.254.10.227 Subnet mask: 255.255.0.0, please add the address of this network segment in the PC first, so that the device can access normally. After the device is started, enter "http://169.254.10.227/".

PC-end software	 Download
Factory reset tool	 Download
.net framework 4.0	 Download
identifyCodeID	1000

Before installing the PC software, please make sure that a newer version of Microsoft .Net Framework has been installed on the PC.

Note: If the download and installation of the software fails, please use IE or Google Chrome to try, or enter the browser settings and cancel the browser download pop-up prompt to try again.

3.2 Using the Software

After enabling the software, the main menu is shown as below:



Click the button **Device List** in the right corner of the main menu, and find all processors on the network automatically. The user may connect to the designated processor based on their own needs; after the connection, the indicator will flash, and one processor supports simultaneous connection and control of up to four users.

: restore default scene

: factory reset

3.3 Custom edit processing module

Click on the edit button, input or output channel processor module right-click selection, edit dialog box, can replace the current processing module, can delete, copy and other operations, edit good click upload to the host. Note: when the CPU display more than 100 will turn red, this time the resource can not be uploaded to the host, need to be re-edited.



3.4 Audio Module Parameters

There are two regulation modes for module parameters: firstly, directly click the input or output channel modules, and enter the parameter interface of the module; secondly, right click the module and the configuration interface will pop out. The first regulation mode is adopted for the following module parameters.

3.4.1 Input Source



Sensitivity: Microphone gain, six grades for your choice (0/3/6/9/12/15/18/21/24/27/30/33/36/39/42/45/48 dBu).

Phantom Power: Provide power for external capacitor microphone, click the button if needed. Do not enable phantom power during line input or when the power is not required, so as not to damage the external device.

Sine Wave: Drag the frequency to generate sine wave with designated frequency (20~20 kHz). You may regulate the output level (unit: dBFS) based on your own needs. Use a fader to adjust or click the text field to designate a value.

White Noise: Observe it on the frequency spectrograph with constant bandwidth, which has a flat frequency spectrum. At this time, frequency regulation will fail, and the level can be used. Each frequency component of white noise has equivalent energy.

Pink Noise: The frequency component powers of pink noise are mainly distributed in the middle and low frequency bands. It decreases with a speed of 3dB/Oct in the middle and low frequency bands. At this time, frequency regulation will fail, and the level can be used.

In addition, you may also find the following menu by right clicking each fader on the main menu.

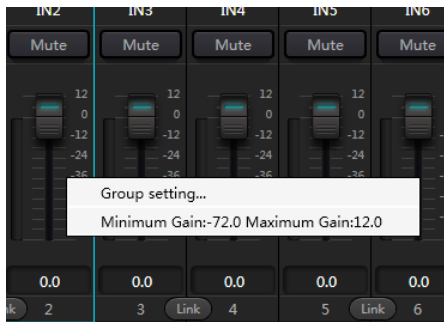

Group Setting: Open the group setting interface swiftly.

Minimum and Maximum Gains: Limit the maximum and minimum of the gain of a channel. After it is commissioned, if you do not wish that the system's stability is affected due to external factors, you may set up a maximum gain.

3.4.2 Expander

The expander has a totally different principle from the compressor. It can expand the dynamic range of a signal. The most fundamental difference in these two devices lies in that, the compressor works on the signal higher than the threshold, while the expander works on the signal lower than the threshold. The expander can turn small signal into smaller one. It can be seen from Fig.3.2 that, when the expansion ratio reaches 1:2, the input signal 20dB lower than the threshold will generate an output signal 40dB lower than the threshold. Thus, as shown below, the signal lower than the threshold will extend downwards and cause smaller level. When an expansion ratio 1:20 is adopted. The expander seems to be a noise gate in terms of the transmission features. In fact, a noise gate is an expander with great expansion ratio.

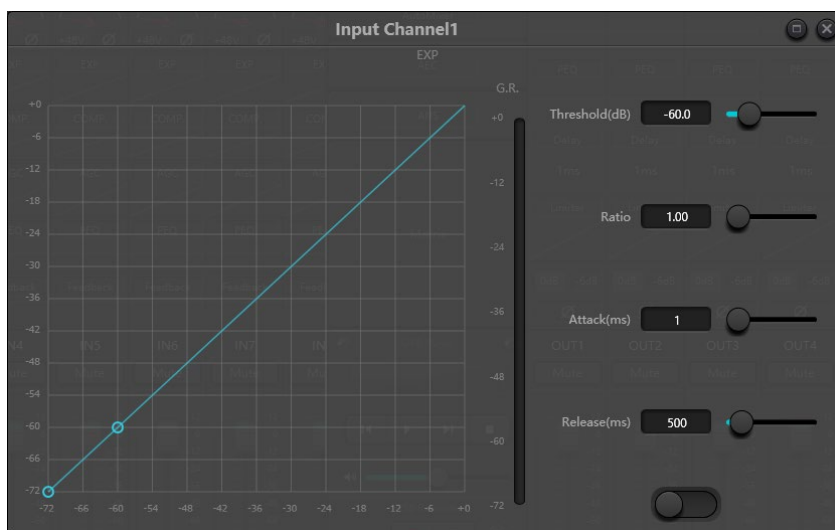

Fig.3.2 Expander

The expander has the following control parameters:

WWW.INTREND-AV.RU

Threshold: The expander can be started only when the signal exceeds this threshold (allowing the transmission of the signal). As a matter of fact, the signal is often set as the ambient noise.

Ratio: It refers to the slope below the threshold point on the gain curve. When the slope is set at a high level, the gate movement will start.

Starting time: It refers to the time required to start the expander when the duration of the input signal exceeds the threshold. Shorter starting time allows us to start the expander more quickly.

Release time: It refers to the time required for the gain to be restored to a value lower than the threshold when the input signal is lower than the threshold.

No matter the starting time or the release time, it just helps to reduce the changing speed of gain attenuation. That is to say, the speed of the gain from -40dB to 0dB is slowed down due to the influence of starting time. The starting time or release time is unrelated to the threshold. If the signal changes below the threshold, the starting time and the release time will have their own respective influence on gain attenuation; when the signal level rises above the threshold, the gain attenuation produced by the expander will disappear in accordance with the speed controlled by the starting time. When the gain attenuation is reduced to 0dB, the expander will stop expansion. Later, when the signal reduces to below the threshold, the expander will start again and the release time will begin to work.

3.4.3 Compressor & Limiter

Compressor

The compressor is used to reduce the dynamic range of the signal higher than the threshold set by the users, and to maintain the dynamic range of the signal lower than the threshold. The compressor has the following control parameters:

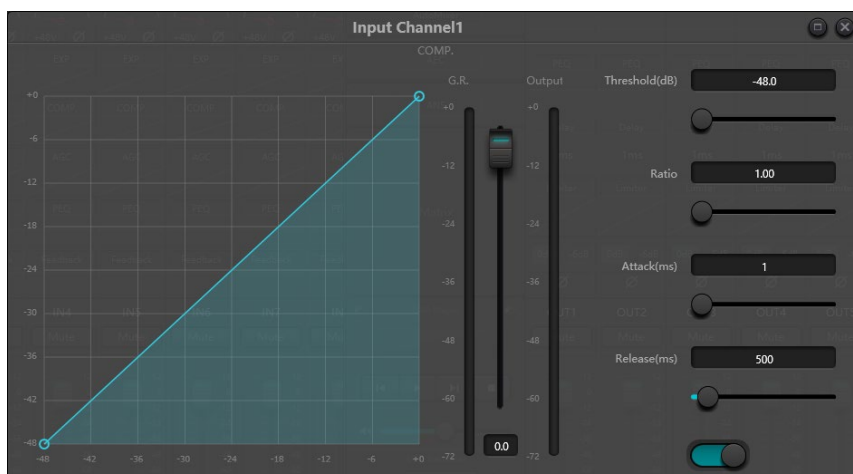

Threshold: When the signal level is higher than the threshold, the compressor/limiter begins to reduce the gain. Any signal that exceeds the threshold is regarded as overshoot signal, and its level will be reduced in normal cases. To a greater extent the signal exceeds the threshold, more level is attenuated.

Ratio: It refers to the compression ratio. The ratio decides the attenuation degree of the overshoot signal to the threshold level. The smaller the compression ratio is, more easily the signal will be higher than the threshold. Once the signal exceeds the threshold, the compression ratio decides the ratio of input signal variation to output signal variation. For example, when the compression ratio is 1:2, if the input signal is 2dB higher than the threshold, the exceeding part only changes by 1dB. A compression ratio of 1:1 suggests that the compressor does not attenuate the signal in proportion. The adjustable range of compression ratio is 1-20.

Starting Time & Release Time: In order to maintain natural oscillation, it is generally hoped that part of the most original level will pass through the compression without any influence (or just minor influence). Likewise, if there is a rapid sharp attenuation and rapid recovery in the signal gain, the suction effect will occur. The starting and release time of the compressor is to avoid such circumstance. The starting time can decide the speed of gain attenuation, while the release time decides the speed of gain recovery.

Output Gain: It is also called gain compensation fader. If the compressor significantly reduces the level of the signal, it may need to enhance the output gain to maintain the volume. Such enhancement applies to all parts of the signal and is unrelated to other parameter settings of the compressor.

G.R. and output Level Meter: G.R. indicates the compressor's compression amount; output refers to the output level of the signal that has passed through the compressor module. The compression amount is displayed in an inverse level meter. If the input signal and threshold are set as -6dB and -30dB, respectively, and the ratio is 2:1, then the compression amount is 12dB; G.R. level meter indicates around -12dB and output indicates around -18dB.

Limiter



The limiter only has one key task: make sure that the signal will not exceed the threshold level in any case. By adjusting the compressor's control parameters, its working modes will be very similar to those of the limiter. The core working principle of a limiter is that it really focuses on the signal below the threshold level as well as how the gain attenuation is produced before the occurrence of overshoot signal. The limit period consists of two processing stages: during the first stage, there is a minor limit, but the overshoot signal will not be processed; during the second stage, if there is overshoot signal, it will attenuate in a very fierce way.

The limiter only provides two parameters: Threshold and Release Time. In terms of signal processing, occasional clipping will be solved via limiter, while the signal level shall be attenuated in terms of frequent clipping.

3.4.4 Auto Gain Control

Auto gain control (AGC) is an exception of compressor. Its threshold is set at a very low level with middle-to-slow starting time, long release time and low ratio. The purpose is to improve the signal with uncertain level to a target level, while maintaining the dynamic range at the same time. Most of the auto gain control includes silent detection to prevent the gain attenuation loss during the silent period. This is the only function that distinguishes auto gain control from ordinary compressor/limiter.

Auto gain control may be adopted to normalize the level of CD players that play background music, foreground music and music on hold, so as to eliminate the changes in the level of some paging microphones.



Auto gain control includes the following control parameters and switches:

Threshold: When the signal level is lower than the threshold, the input-to-output ratio is 1:1. When the signal level is higher than the threshold, the input-to-output ratio changes with the ratio control settings. The threshold is set as the background noise just higher than the level of input signal.

Ratio: It refers to the ratio of the changes in the level of the input signal higher than the threshold to the changes in the level of the output signal.

Target Threshold: It refers to the level of output signal required. If the signal is higher than the threshold, the controller will compress the signal in proportion.

Starting Time: It refers to the response time required to control the level higher than the threshold.

Release Time: It refers to the response time required to control the level lower than the threshold.

3.4.5 Equalizers

The equalizer is mainly used to correct the frequency range that is overemphasized or gets lost, no matter it is wide or narrow. In addition, the equalizer can also help us to narrow or widen the frequency range, or change the amount of a component in the frequency spectrum. To get it simplified, the equalizer can be used to change the tone of the signal.

The equalizer has the following control parameters:

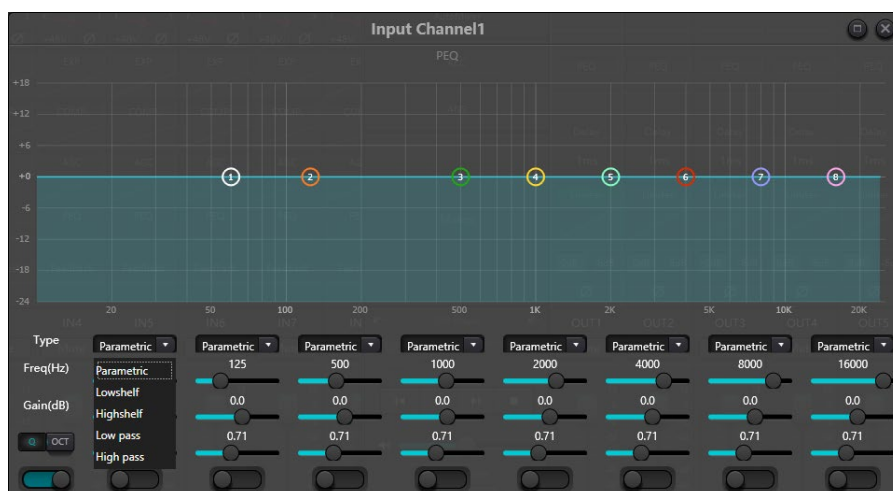

Fig.3.6 Equalizer

Type: Parametric EQ is a default. High & low shelf filters and high & low pass filters can be selected. Each kind of filter has different forms to achieve different functions.

High & Low Pass Filter: The reference frequency of pass-type filter is called cut-off frequency. Pass-type filter allows the frequencies on one side of the cut-off frequency to fully pass the filter; in the meantime, the frequencies on another side of the cut-off frequency are attenuated on a consecutive basis. Among them, high pass filter allows the frequencies above the cut-off frequency to pass and filter the frequencies below the cut-off frequency. To the contrary, low pass filter allows the frequencies below the cut-off frequency to pass and also filter the frequencies above the cut-off frequency.

High & Low Shelf Filter: It is also called shelf filter. High shelf filter means that the gain enhances or attenuates for the frequencies above the set frequency. Low shelf filter means that the gain enhances or attenuates for the frequencies below the set frequency. The set frequency is not 3dB cut-off frequency but refers to the center of the falling edge or rising edge of the filter. Q value affects the peak, and has a mathematical relation with the peak.

Frequency (Hz): It refers to the center frequency of the filter.

Gain (dB): It refers to the enhanced or attenuated decibel value of the gain at the center frequency.

Q: It refers to the quality factor of a filter. The adjustable range of Q value is 0.02-50;

When the filter is a parametric EQ filter, Q value refers to the width of the bell-shaped frequency response curve on both sides of the cut-off frequency.

When the filter is a high & low shelf filter or a high & low pass filter, if $Q > 0.707$, there will be peaks in the filter responses. If $Q < 0.707$, the slope will become flatter, and the roll-off will occur in advance.

Each segment of equalizer has a switch, which is used to turn on or turn off the corresponding segment. After being closed, the parameter setting will not work. The equalizer has a master switch, which is used to enable or disable a module.

Parametric equilibria have 5,8,12 options

3.4.6 Figure Balancer

By using constant Q value technology, each frequency point is equipped with a push-pull potentiometer. The bandwidth of the filter remains unchanged regardless of the frequency raised or attenuated. The common professional graphic equalizer is to divide 20 Hz~20 kHz signals into 10,15,27,31 to adjust.

The graphical balance currently has 10,15 and 31 options



3.4.7 Feedback Inhibition

While using the feedback inhibition module, we'd better combine well with good systematic designs and practical projects but not to replace good systematic designs. The traditional methods shall still be used, such as limiting the number of microphones to be opened, minimizing the distance between sound source and microphone, positioning the microphone and loudspeaker to get

minimum feedback, and balancing the room to get flat response. Later, we can adopt feedback inhibitor to get additional gain. The feedback inhibitor cannot be used to magically solve the system's design defects or improve the sound transmission gain in a way exceeding the system's physical limitations.

Feedback inhibition module automatically detects and inhibits the sound feedback in the sound system. The module distinguishes feedback from expected sounds based on the characteristics of signals. When a feedback at a certain frequency is detected, a notching filter will be automatically added at the feedback point to attenuate it. During the first addition, the notching filter only attenuates the feedback a bit. If the feedback still exists, the notching filter will continue to attenuate the feedback in accordance with the preset parameters until the feedback disappears or reaches the maximum preset parameter. Multiple user parameters can be used for accurate fine tuning of the effects of the module.

After the buzzer output, the filter may be locked up to prevent any change during the performance period. The filter settings can be copied to a dedicated notching filter module (such as equalizer). Eight filters are set as auto filters in an automatic cycle. In this way, those filters for temporary use can be removed.

Each channel has a feedback inhibition. Use a mouse to drag the input module and find the feedback inhibition module or rapidly enter the feedback inhibition module by clicking the shortcut key on the right. If the feedback inhibition module needs to be enabled, click to enable the button and automatically detect the feedback point, and use a narrow-band filter for elimination. Each feedback inhibition module has 8 narrow-band filters.

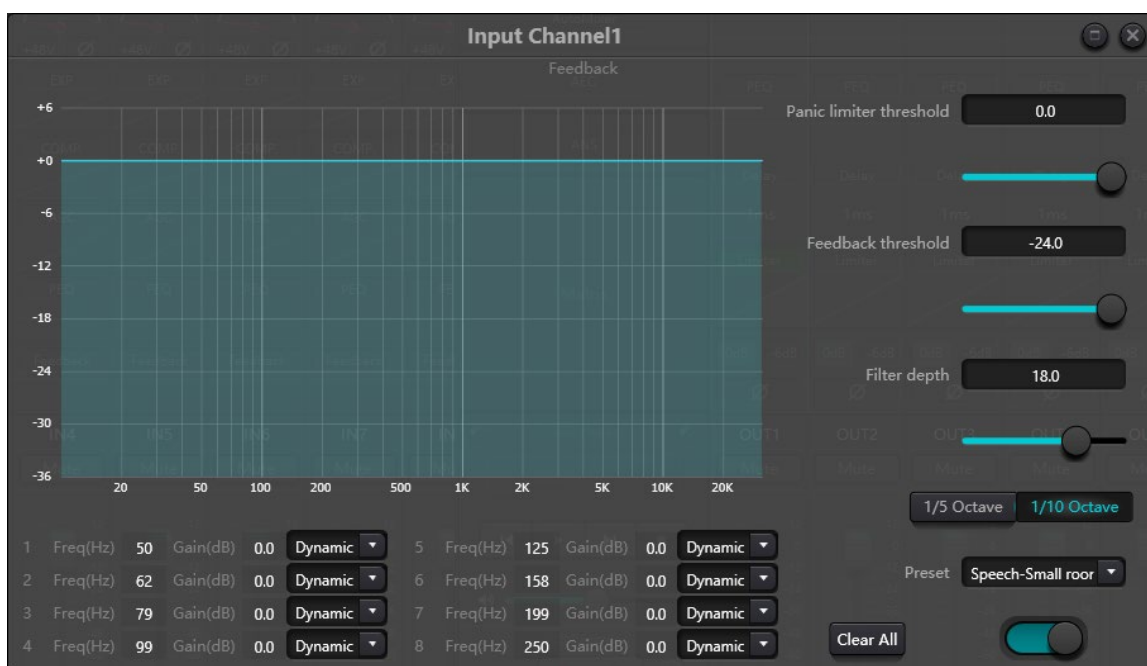

The feedback inhibition module has the following adjustable parameters:

Panic Threshold: According to this parameter, "any level higher than the threshold is absolutely a feedback". When a signal level is higher than the feedback threshold, any of the following circumstances will occur: a) the output gain is temporarily attenuated to control the speed of feedback; b) the output level is restricted to prevent out of control; c) the filter's sensitivity is increased for faster detection and feedback. Once the output level is lower than the threshold, the gain will be recovered, and the sensitivity is restored to normal state. This value refers to the peak value of digital range signal. If the value is set as 0, this function is disabled.

Feedback Threshold: According to this parameter, "any level lower than the threshold is absolutely not a feedback". This may prevent the module detects feedback in a soft music or due to the noise of low level.

Filter Depth: It refers to the maximum attenuation of a single filter. A shallow setting may prevent too much damage caused by the filter or notching filter to the signal. It may cause worse feedback control, especially in a large narrow resonance system.

Bandwidth: 1/10 and 1/5Oct can be chosen. A constant Q value is adopted. The filter will not become wider due to the increase of depth. It is recommended to use the filter in the phonetic environment. In the case of frequent feedback, the bandwidth is set at 1/5Oct because it has wider bandwidth and greater influence.

Preset: There are four built-in presets: "big music room", "small music room", "big voice room" and "small voice room". These four presets apply to the default settings of most applications.

Notching Filter's Auto Mode: Auto mode is set for the notching filter. After eight filters are used up, a new feedback is detected, and the module will check "auto" filter and use it to inhibit new feedback. Each notching filter has three modes: auto, manual and fixed modes. When Manual mode is set for the filter, the gain can also be manually set. When Fixed mode is set, the filter always works and will not be occupied by new feedback points; it still works when being rebooted. If you need to save these feedback parameters, please click to save the preset button.

Clear: Click the button to instantly clear up all filters. It will clear up all feedback points detected with inhibition previously. This operation is generally done when recommissioning the feedback module.

Feedback inhibitor can be used as a tool during the system commissioning to identify feedback points or as a preventive measure during normal operations. If you want to get higher system transmission gain and feedback inhibition effect, it is recommended that you debug by following the steps below:

- (a) Reduce the system gain, and use the button "Clear" to reset all filter parameters

(b) Set up parameters for the feedback inhibition module. Also, decrease the panic threshold to reduce the feedback level.

(c) Open all microphones, and slowly increase system gain until the feedback occurs. Stop increasing system gain when the feedback occurs.

(d) Wait for the feedback inhibition module to take effect; after the feedback disappears, continue to increase gain.

(e) Repeat the operation until the system reaches the required gain or until all filters are fully distributed

(f) Change the panic threshold to a maximum level just higher than the expected non-feedback signal.

At this time, if needed, you may set Fixed mode for each filter or save the dynamic status to deal with possible feedback during the performance period. Additionally, you may copy the filter to the notching filter module (such as equalizer). In this way, you may add more filter capacity.

If a speaker is included among the devices used, it is recommended to use a compressor/limiter module for additional protection. You may set an appropriate limiter to make sure that the speaker will not get damaged even if all notching filters are used up or the feedback inhibitor cannot effectively control the feedback, such as in the case of excessive system gain.

3.4.8 Noise Gate

Noise gate: the main purpose of a noise gate is to attenuate signals below the threshold, and this attenuated signal is usually noise.

Threshold: greater than pass, less than attenuation

Depth: attenuation, which determines how much the signal below the threshold is attenuated.

Start time: start time refers to the speed at which the noise door opens.

Release time: the release time is opposite to the start time, which refers to the speed of the noise door closing.

Keep time: keep time is like this, when the signal is below the closing threshold, normally, the

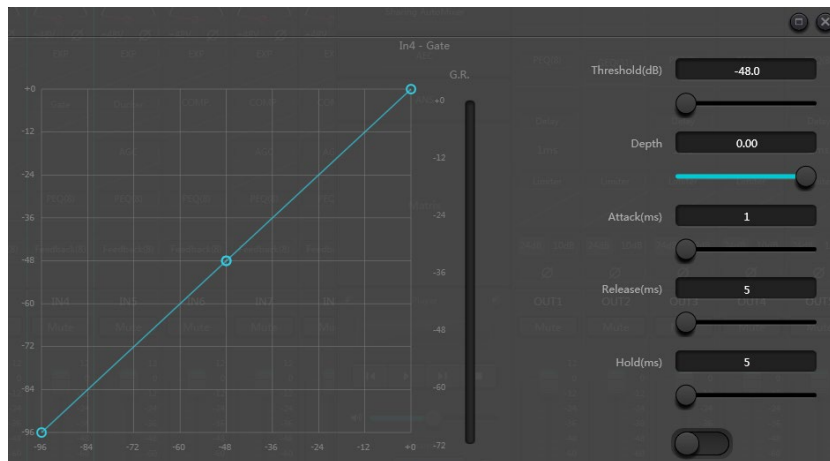

3.4.9 Ducker

Ducker: when the level of one channel exceeds the specified threshold, the level of the other channel will be attenuated, which is the dodging effect.

Threshold: the reference signal begins to decay above the threshold and recovers below the threshold.

Depth: the amount reduced by the evasive signal.

Start time: when the reference signal is above the threshold, the time to begin to attenuate the evasive channel signal.

Recovery time: after the reference signal is below the threshold, the evasive signal returns to the original signal size.

Hold time: hold time refers to how long the dodging on the dodging channel remains after the control signal is below the threshold.

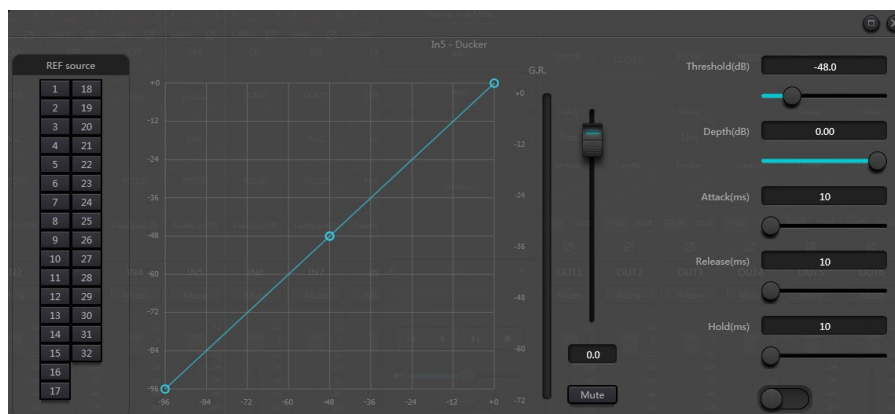

3.4.10 Spl

Noise gain compensator: automatically adjust output volume according to ambient noise induction and processing.

Maximum gain: the maximum amount that can be adjusted.

Minimum gain: the minimum amount that can be adjusted.

Gain sensing ratio: the ratio of lifting or attenuation.

Speed: the speed of lifting or attenuation.

Trim: gain.

Noise threshold: greater than the starting gain, less than the reduction.

Distance: distance between reference and local signals

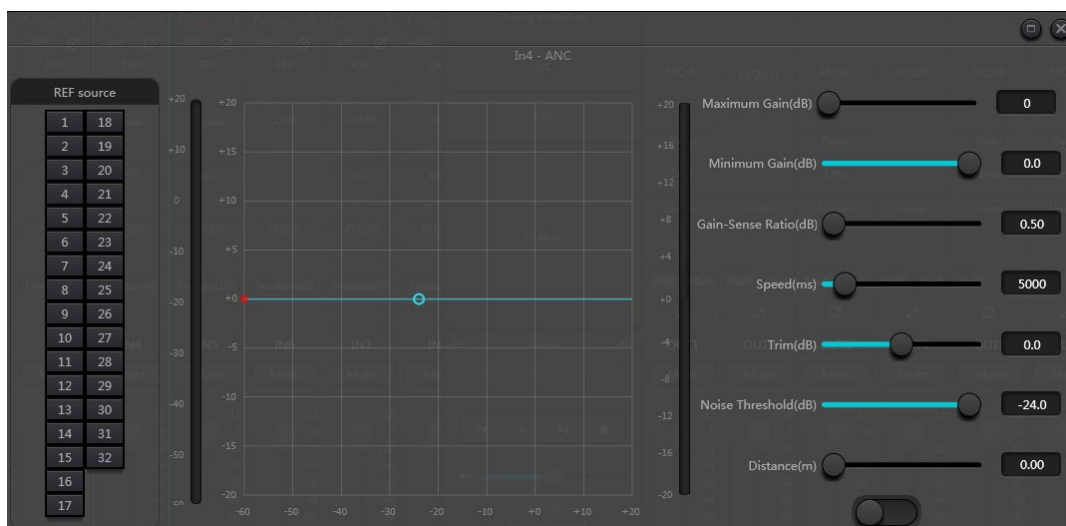

3.4.11 AutoMixer

In a conference room, if several microphones are opened to the same gain level and there is only one person speaking, the microphone effect may be not clear. Other microphones will pick up noise and reverb in the room. When these signals are mixed with normal microphone signals, audio output quality will be greatly reduced and the whole amplifying system will easily get squealing, which will result in sound transmission gain. To solve the issue, other unused microphones shall be closed. Automixer may close them at a higher speed than manual operation.

There is a built-in gain share automixer inside the processor. It supports up to 32-channel audio signal output. There is a direct output at each channel of auto mixing matrix, which is only influenced by

channel mute instead of auto gain and channel fader. Channels suitable for fixed volume like the channel of background music need to keep at a fixed level without being controlled by automix. For example, it shall keep microphone at normal open. Meanwhile, its gain will not be influenced by automix. At this point, users may directly adjust the output of the channel in output matrix route as well as turn off automix button of the channel. Its gain will not be adjusted and gains at other channels will not be influenced by the signal level at the channel.

There are two groups of control parameters in automix module: main control parameters and channel control parameters.

(1) Main control parameters

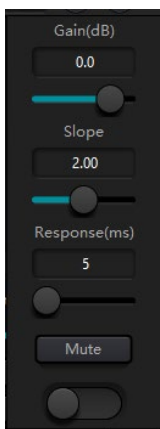

Click the bottom button to open or close automix

Gain: control main output volume of aumomix

Slope: The slope control influences the attenuation of lower level. If the slope is higher, the attenuation of lower level channel will rise. The slope control and the ratio control at the expander have the same working mode. It is suggested that the value be set at or around 2.0. if it is set at 1.0, the effect equals to closing automix at all channels. if it is set at 3.0, the action will result in larger gain adjustment, which may bring unnatural effect. The bigger the value, the more the channel is opened and the more the total attenuation. When the slope is set at 2.0, ideal gain share may be realized, so it is the preferred value in use.

Response Time: Faster response time may ensure head letters of speeches not be cut off. Slower response time allows smooth operation. Practices show that the best effect will be produced when response time is between 100ms and 1000ms. The design of auto gains aims to faster microphones turning on than turning off. Therefore, head letters of speeches will not be cut off even the response time is 100ms. If it is set at several seconds, then there will be a longer hold time of the response time of automixer, previous active channel will be saved at open status in several seconds.

(2) Channel control parameters

Auto Mix: Each channel has an automix on/off button which must be turned on for channels need to participate in automix. It may also be closed, and then the channel will not participate in automix.



Mute: Both channel mute and fader are behind auto gain. If the channel level is bigger, the level gain of other channels may also be reduced even the channel mute is on.

Gain: Gain fader adjustment may increase/decrease the volume proportion in automix.

Priority: Priority setting may give priority treatment to high priority channels than low priority channels, and thus automix algorithm will be affected. Priority parameter ranges from 0 to 10. The bigger the value, the higher the priority.

Both channel mute and fader are behind auto gain. Any adjustment made towards these two parameters won't influence the operation of automix. For example, If the channel level is bigger, the level gain of other channels may also be reduced even the channel mute is on. Channel mute shall be turned on and automix shall be turned off to set signal mute and prevent its influence on automix. Mute button at each channel shall be muted and directly connect output mute when mixing sound. Channel faders also control sound mixing level and direct output level of channels. Click the textbox and input a dB value to control channel level precisely.

Priority control allows high priority channels to cover low priority channels, and thus automix algorithm will be affected. Priority value can be set from 0 (the lowest priority) to 10 (the highest priority), and the default value is 5 (standard priority). Users may use slider or click textbook to input a specified priority between 0 and 10 to adjust priority. Value increasing means priority increasing.

If two channels have the same signal level, then the channel with higher priority will get more auto gain. If there is one-unit priority between them, then the channel with higher priority will get extra sound mixing gain of 2dB (suppose the slope of the two channels is set at 2.0). For example, if channel 1 and 2's priorities are respectively set at 6 and 3, and the input level of those two channels are the same, then Channel 1 will get extra sound mixing gain of 6dB than Channel 2. During operation, it shall be noted that the slope setting of main control parameters will also influence sound mixing gain difference brought by the priority weight of channels. If the slope is set at 3.0, then one priority unit difference will result in gain difference of 4dB. If all channels have the same priority, then their priority settings shall be at 5.

Note: In some settings, users shall be very careful when using ultra priority differences between channels, such as priority of 0 and 10. If channels with ultra high priority recognize signals like

background music from speaker, then it is possible for them to mask channels with lower priority even the former is not used. It will get worse if the slope is higher. If the issue happened during installation and commissioning, users may consider installing a noise gate or expander between automixers at the highest priority channels. Meanwhile, they shall set threshold at the level that it won't be opened by the noise gate or expander.

Also add a threshold type automatic mixer option:



The threshold automatic mixer is based on the noise gate development, each channel has a noise gate, which is either open or closed.

Gain: the overall output gain of the automatic mixer.

Hold time: the Hold function can adjust the length of time the channel remains open after the speaker stops speaking. This function ensures that a brief pause between words and phrases does not cause the channel to close.

off gain: When the sound cannot pass through the threshold, the set value of off gain will be added to the sound signal.

Sensitivity: sensitivity control, when the channel above the adaptive noise threshold must be conducted on the channel. If the value of this setting is increased, the channel is easily switched on at very quiet noise.

NOM Atten: NOM attenuation push can affect the magnitude of attenuation of all channels when more microphones are opened. This parameter reflects the attenuation when two microphones are switched on, and the additional attenuation that will increase after each double number of open microphones. When set to 3 dB, for example, opening two microphones attenuates 3 dB, 6 when opening four dB, 9 when opening eight. By the same token, the number of microphones turned on doubles, and the output attenuation increases by 3 dB.

NOM Limit: set the maximum number of open microphones

Noise threshold: greater than this value open, less than this value attenuation

3.4.12 Echo Canceller

Acoustic echo canceller (AEC for short) is a kind of digital audio signal processing technology. It is used in audio/video conference when conferees in local conference room are talking with one or more speakers certain distance away. AEC program increases remote speaker' s phonetic intelligibility via cancelling acoustic echo generated in local room.

Echo cancellation module for remote calls can be used to carry out local amplification of remote voice signals and attenuate the interference caused by acoustic echo. Its basic operation principle is simulating echo channel, estimating possible echo generated by remote signals and then minus the estimated signal from input signal of microphones, and thus there will be no echo generated in input voice signal to achieve the goal of cancelling echo.

There is only an echo cancellation module in DSP Controller. Two local input and remote output mixers are preset to realize multichannel signal participating echo cancellation as shown in the figure. A parameter can be adjusted:

Non-linear filter (NLP): Three types including Conservative, Moderate and Aggressive can be selected to determine echo suppression level.

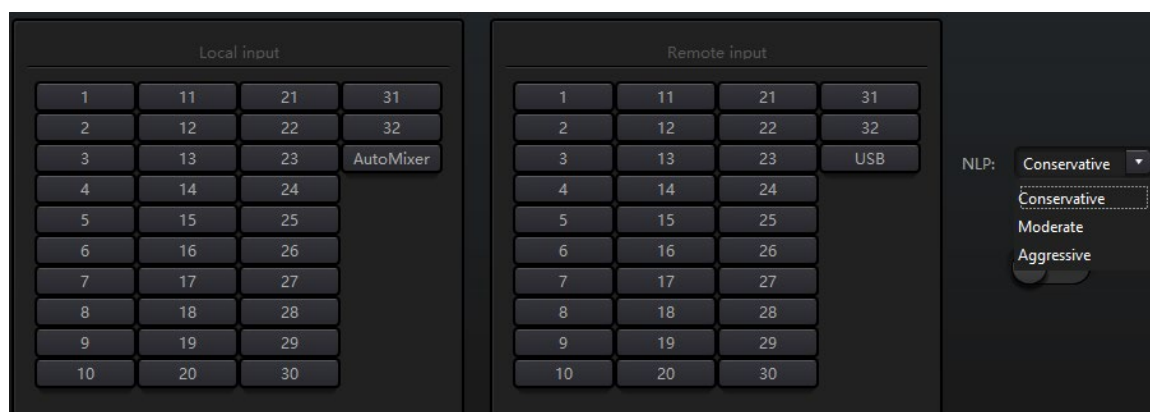

Note: The settings of echo cancellation module shall be used cooperatively with matrix module setting signal router.

3.4.13 Noise Suppression

Noise suppression module can remove non-human voice effectively. It may distinguish human voice from non-human voice and treat the latter as noise. After its processing, only human voice is theoretically left for an audio file consisting both human voice and noise.

There is only an echo cancellation module in DSP Controller. Multichannel mixers are preset to realize multichannel participating noise cancellation as shown in the figure.

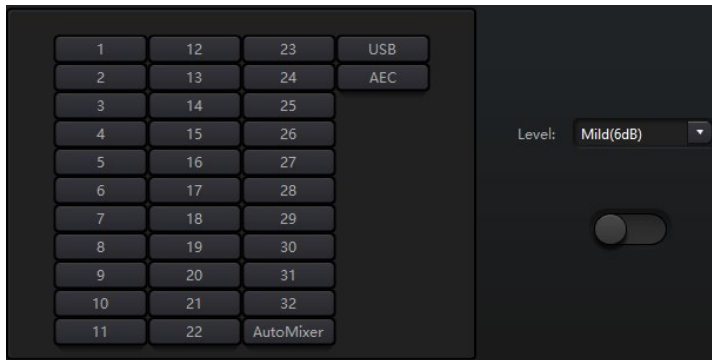

Suppression level: There are totally three levels including Mild(6dB), Medium(10dB) and Aggressive(15dB) for selection. dB here refers to the decibel of suppression noise reduction. The bigger the value, the more harm on voice generated, which is inevitable.

3.4.14 Matrix

Matrix has dual operation functions including router and sound mixing. As shown in the figure, the horizontal direction indicates the input channel and the vertical direction indicates output channel. One-to-one input and output is the default setting. If it's necessary to mix voices of channel 1 and channel 2 and then output to channel 1, users only need to click 1s on both horizontal and vertical directions at output channel 1. If input 1 and 2 participate in automixing, then the output will not be influenced by it. Similarly, after setting automixing, echo cancellation and noise suppression module, users also need to set matrix to get correct signal route relation.

3.4.15 High & Low Pass Filter

Each output channel provides high- and low-pass modules which consist of high- and low-pass filters. Each filter has four kinds of parameters as follows:

Frequency: The cutoff frequency of filters. The cutoff frequency of Bessel and Butterworth is defined at -3 dB, and the cutoff frequency of Linkwitz-riley is defined at -6dB.

Gain: Gain setting influences the promotion and attenuation of full band.

Type: There are three types of filters including Bessel, Butterworth and Linkwitz-riley. Butterworth has the flattest passband.

Slope: It refers to attenuation values of transition zone of filters. There are totally 8 attenuation values including 6, 12, 18, 24, 30, 36, 42 and 48dB/Oct. For example, 24dB/Oct indicates that the attenuation range is 24dB for each octave difference existed in frequency in transition zone.

Users may click bottom activate button to activate high- or low-pass module.

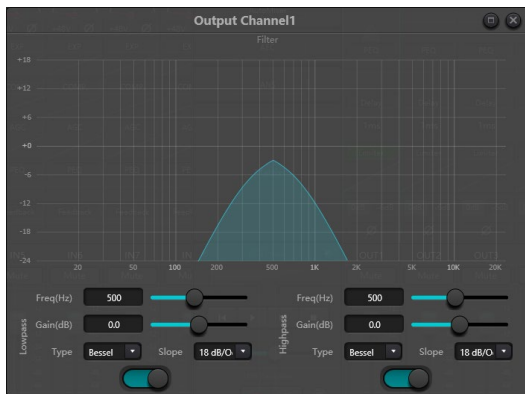

3.4.16 Delayer

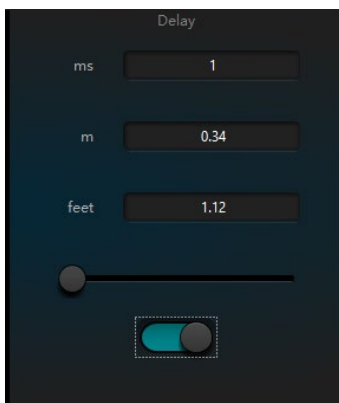

Activate button: Activate appointed delay module in modules and insert it into audio signal path to increase fixed delay time for signals.

Millisecond: Set delay time of delayer. The value ranges from 1 to 1, 200 milliseconds. Both meter and feet are alternate units for millisecond.

3.4.17 Output

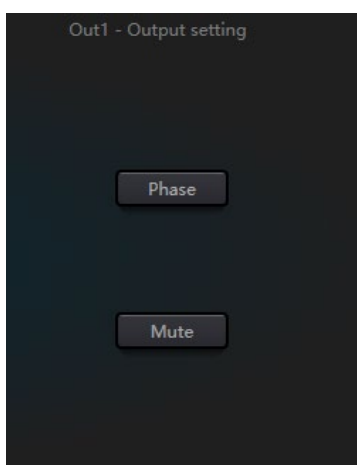

Invert: 180-degree audio signal phase invert.

Mute: Set mute/unmute.

Similarly, users can use right button to set part menu at output channels, which can be carried out based on requirements.



3.4.18 Camera Tracking

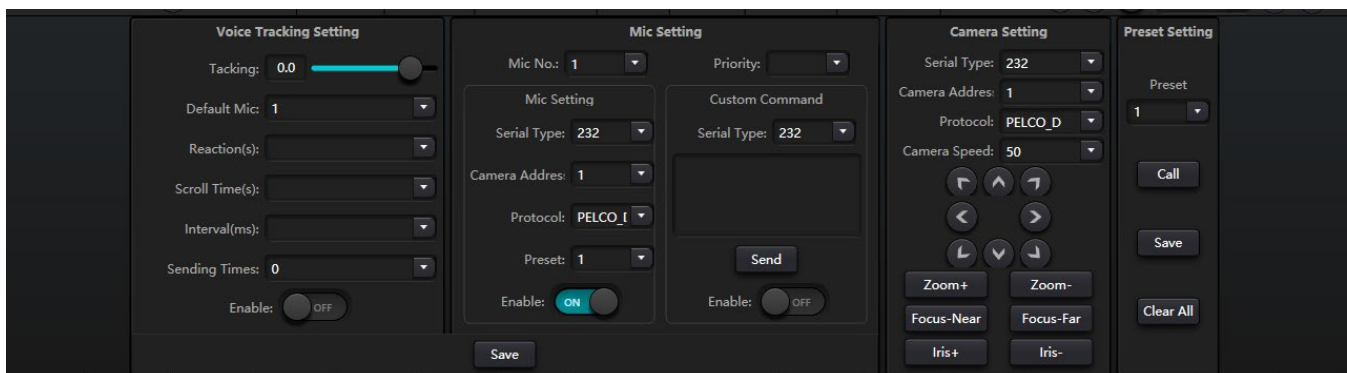

Voice tracking set tracking threshold: detect microphone input signal greater than or equal to tracking threshold, the system automatically enable tracking parameters

Default Mike: when all Macs are not input, turn the camera to the default MIC set position
 reaction time: the maximum intermittent time of the valid signal. If the microphone is used to speak, the reaction time is set to 3 seconds, and the signal is still considered to be valid for 3 S in the middle of the speech, and more than 3 S, is regarded as invalid.
 Cut back the default Mike time: the shortest speaking time required for the camera to switch to a valid position. If the microphone is used to speak, the speaking time must be longer than the "switching time ", the channel signal is considered to be valid, and then the camera automatically turns to the set position. Usually "switching time" is greater than "reaction time ".
 Wheel gap: the number of times each time a camera switch command is sent: the number of times a camera switch command is sent, such as 0 for special processing, only once triggered.

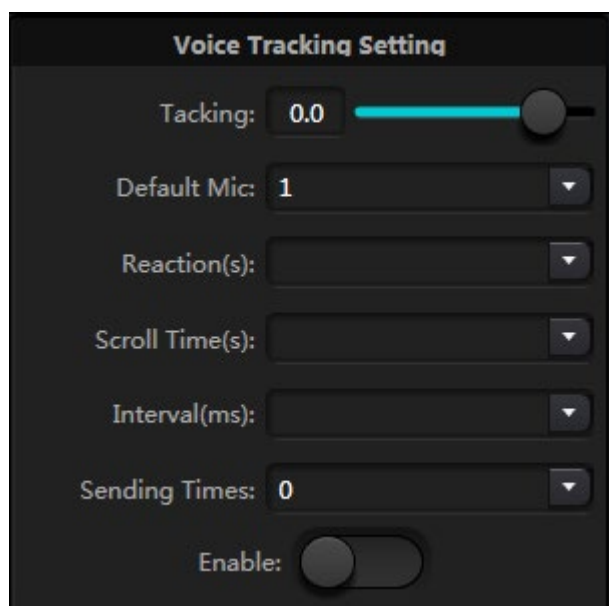

Mike sets the microphone number: generally corresponding to the input channel of the device, that is, the channel number connected by the Mike. Priority: the smaller the priority series, the higher the priority level, when the priority is the same, according to the trigger priority order; if two Mics speak at the same time, The camera automatically rotates to the preset bit corresponding to a Mike with a small priority (that is, high priority) or sends a command corresponding to a Mike with a small priority (that is, high priority); but if the two Mics have the same priority, the first checked signal shall prevail. preset point, serial port number, camera address, protocol and camera related, must correspond to the actual connection of the camera. Enable: when the device detects an input signal (usually when someone speaks), it automatically sends the corresponding command to the defined serial port, and then it can set the command in advance. But without checking enable Custom Command, the device does not send automatically, but can still click the send button to send input box command to the specified serial port. Click Save to save the parameter to the device, when the channel's Mike is associated with the corresponding camera address. Then the "enable microphone setting" option is used to determine whether the microphone setting is a camera debugging interface when tracking is enabled. Finally, the parameters of this part will be saved on the camera.

3.4.19 USB Soundcard

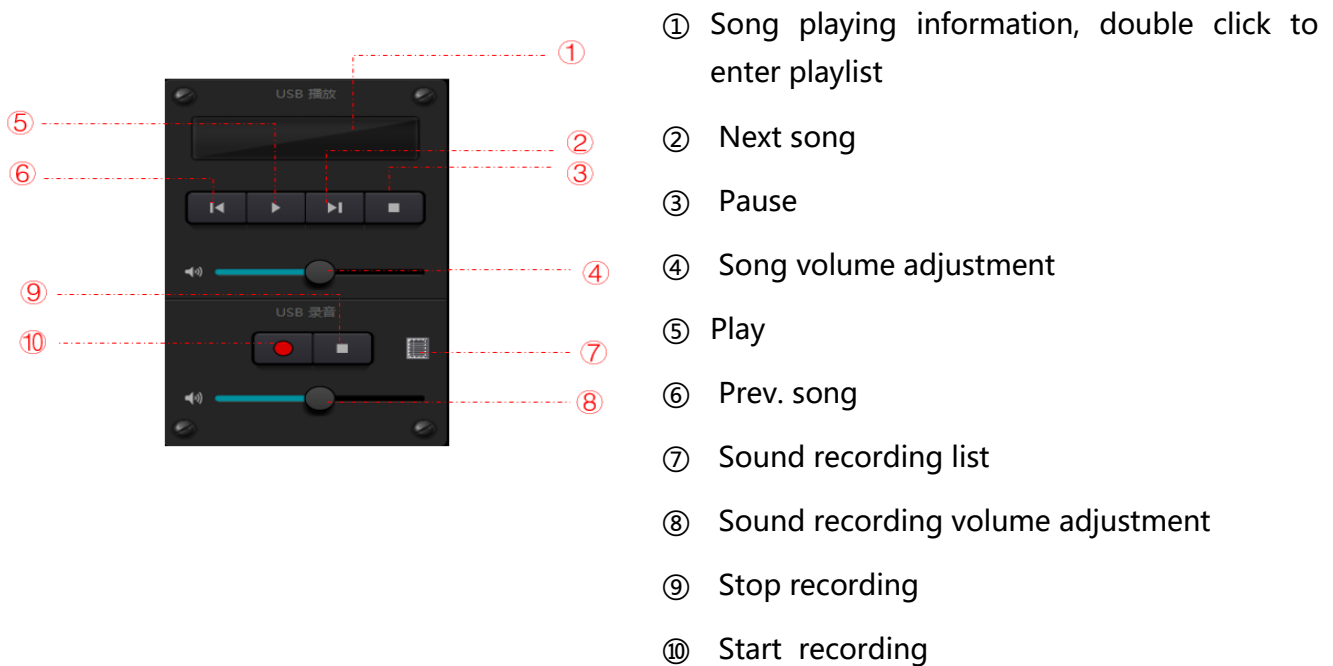

USB soundcard is used to carry out two functions, realizing recording and broadcasting and teleconferences using personal computers. After going through echo and noise cancellation modules, USB voice may access to teleconferences easily. USB broadcasting function on the software interface can only be used for recording and broadcasting function.



Soundcard Setting

USB cable with double ends of Type-A can be used to connect DSP processor and computer host. For initial connection, "Found New Hardwar" will pop up on computer screen, and the driver will be installed automatically. After installation, USB soundcard will appear in computer soundcard list as shown in the figure. Users may select USB soundcard in soundcard setting at software playlist.



Users may operate song files in playlist as well as save them as playlist. They may also directly open them when using the device next time. As shown in the figure, click  at the bottom of the playlist to open file folder and select songs to be played,  to clear the playlist and  to enter the interface of soundcard setting.

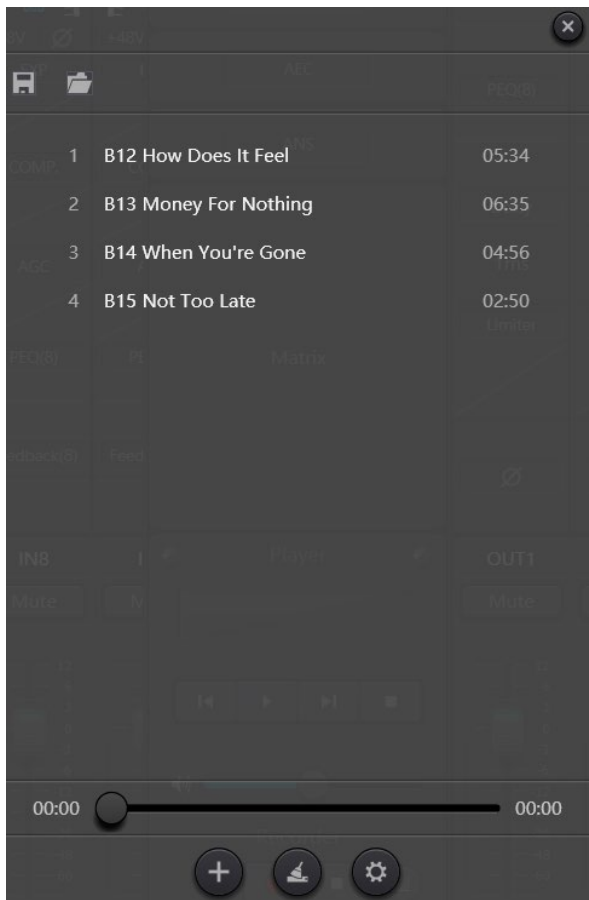

3.5 Setting Menu

3.5.1 File Menu

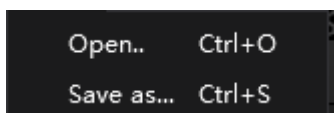

In offline mode, click the pop up file dialog and open an existed default document with suffix *.uma, or right click on the default document to open DSP.exe.

“Save as” refers to saving presets on the application to local hard risk to realize easy copy and store.

3.5.2 Device Setting

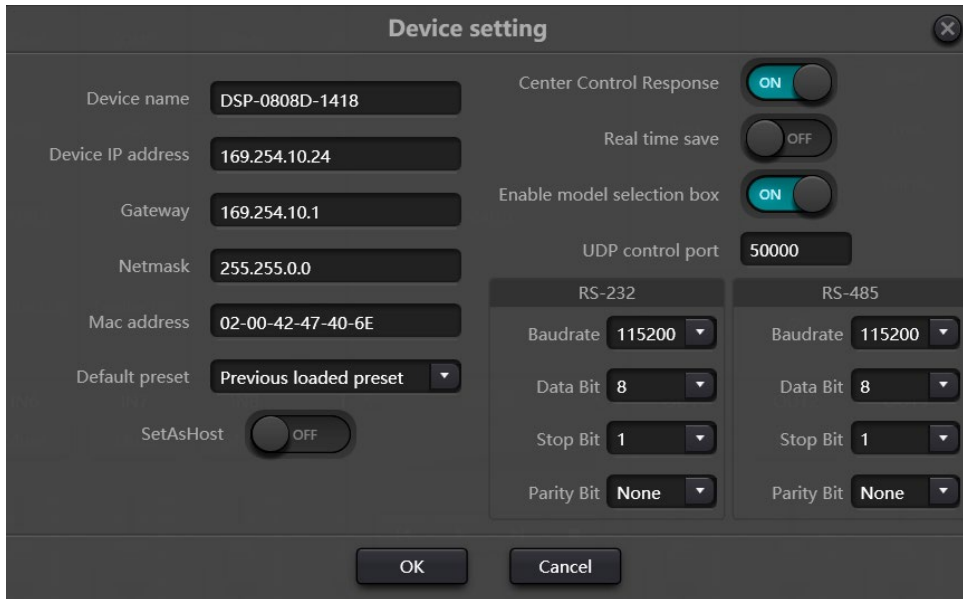

Information like device name, network address and SERBAUD can be set on device setting. The maximum length of the device name is 16 characters or 5 Chinese characters.

Default startup: Two startup preset modes are available for selection. One is any preset from 16 presets acting as startup preset. Each boot will start with it. Another is selecting previous upload preset and taking the last preset before power outage as the preset of next startup.

3.5.3 GPIO Setting

Open the software interface of GPIO settings. The device has total 8 GPIOs that allow independent input or output configuration.

Input GPIOs have preset, router, gain, mute, command, analog-to-digital gain for selection.

Output GPIOs have preset, level, mute and command for selection



Input GPIO Setting

Preset



Trigger types: high level trigger/low level trigger/high level trigger, low level cancellation/low level trigger, high level cancellation, i.e., rising edge/falling edge trigger/rising edge trigger, falling edge cancellation/falling edge trigger, rising edge cancellation

Preset: It will change to preset when jump type of hardware GPIO port and trigger type of software setting are consistent.

Routing

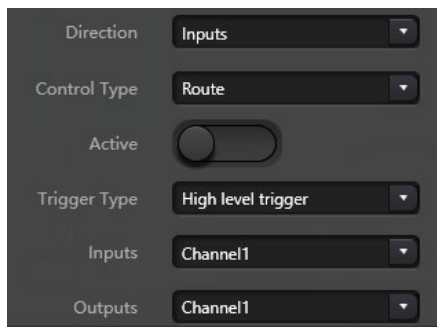

Trigger types: same as above

Input & output: select input channel mixing corresponding to output channel.

Carry out mixing/cancel mixing action when the trigger condition is satisfied.

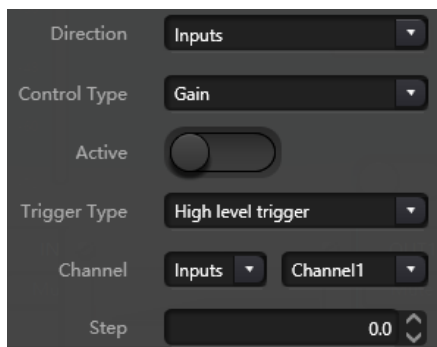
Gain

Direction: Inputs
 Control Type: Gain
 Active:
 Trigger Type: High level trigger
 Channel: Inputs Channel1
 Step: 0.0

Trigger types: same as above

Channels: select input or output channel

Step length: increase step length in dB based on original gain got by the channel.

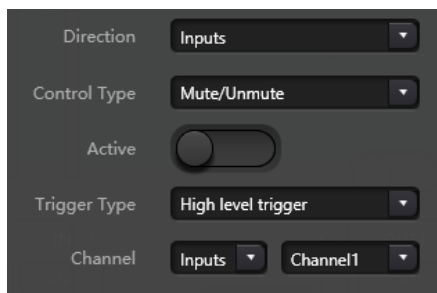
Mute/Cancel Mute

Direction: Inputs
 Control Type: Mute/Unmute
 Active:
 Trigger Type: High level trigger
 Channel: Inputs Channel1

Trigger types: same as above

Channels: select input or output channel

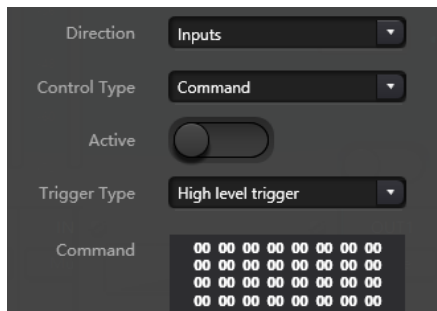
Command

Direction: Inputs
 Control Type: Command
 Active:
 Trigger Type: High level trigger
 Command: 00 00 00 00 00 00 00 00
 00 00 00 00 00 00 00 00
 00 00 00 00 00 00 00 00
 00 00 00 00 00 00 00 00

Trigger types: same as above

Command: The command code will be sent through RS232 when the trigger condition is satisfied

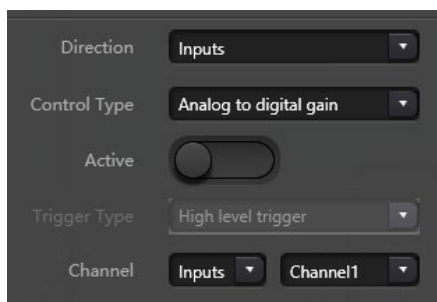
Analog-to-digital Gain

Direction: Inputs
 Control Type: Analog to digital gain
 Active:
 Trigger Type: High level trigger
 Channel: Inputs Channel1

Analog-to-digital gain is very useful when connecting potentiometer externally. It may adjust input or output channel gain. It looks like rotary encoder. The difference between them is potentiometer analogs and adjusts voltage and current while encoder is digital and transmit the binary codes of 0 and 1.

Output GPIO Setting

Preset

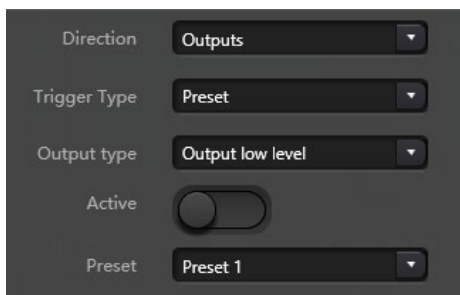

Output types: high level/low level

Preset: Corresponding GPIO port outputs high level or low level when changing to it.

Level

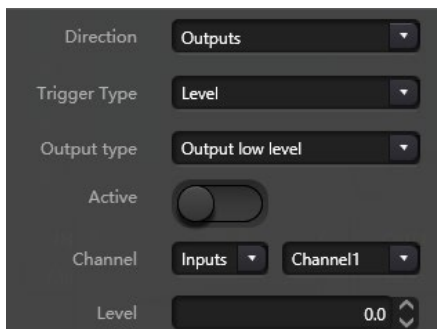

Output types: high level/low level

Channels: appointed input or output channel

Level: GPIO outputs high/low level when appointed channel level reaches preset level threshold.

Mute

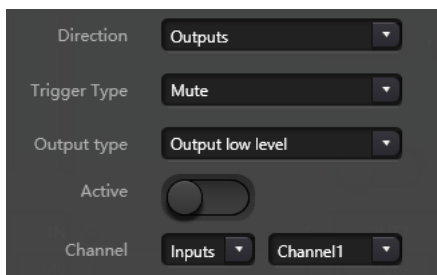

Output types: high level/low level

Channel: Appointed input/output channel. Preset high/low level is output when the channel is muted. On the contrary, the opposite level will be output when cancelling mute.

3.5.4 Group Setting

The grouping interface is divided into two labels: input and output, and grouping can be set under each label. A channel can only participate in one group. Under the same group, their channel volume adjustment and mute adjustment are synchronized. The biggest difference from the Link function is that other module parameters are not synchronized.



Each group can select 1-device maximum number of passes. The maximum number of channels for the device depends on the model you purchased. The channel is set as a group, which will be distinguished by a color on the Home screen.

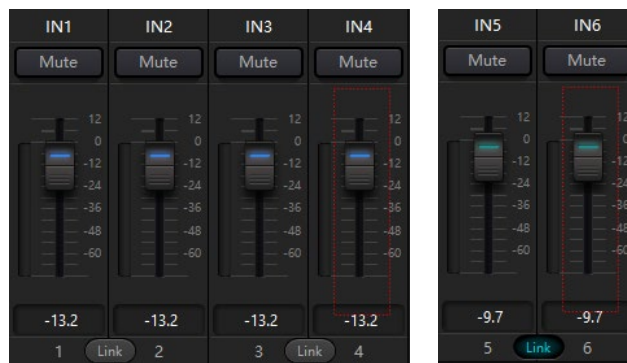

The relationship between groups and link: The channel participating in group won't participate in LINK, which means group's priority is higher than LINK. The difference between groups and LINK is that groups can only control channel gain and mute while LINK links all parameters at the channel.

3.5.5 Panel Setting

Panel setting include two panel types which are button and OLED panels. Use cables to connect multiple physical panels with DSP device via panel setting, and then achieve the aim of panel controlling DSP device by setting panel easily.

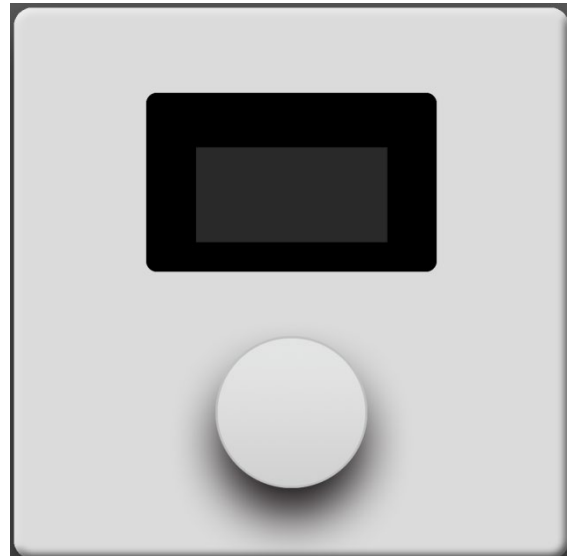
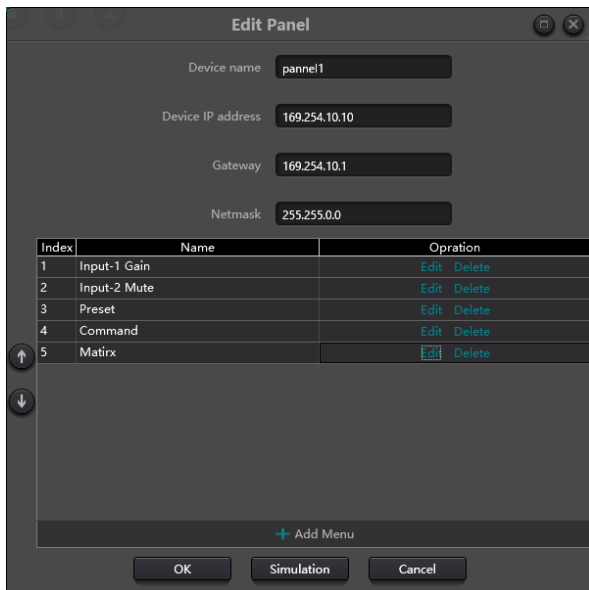

Click "add menu" to pop up menu selection box, choose corresponding menu and confirm it. After finishing the setting of software menu configuration, click toolbar download icon to download the configuration to panel hardware.

Operation steps of panel:

1. Display panel name and IP address on main interface and turn the knob left or right to switch menu.
2. Press the button on the knob, and the second row on menu interface starts to flash, which indicates that it enters edit mode.
3. Turn the knob left or right to change value.
4. Press the button on the knob again to edit mode and go back to menu mode.

Key Panel:

There are 8 keys and one knob on key panel. The knob is used to adjust gains, and 8 keys can be used to realize different functions through programming. There are four types of key functions, including volume adjustment, mute, preset and command. Drag an item in function area to appointed key to finish programming of the key.

Similarly, after finishing all programming, users may use the emulation button to check whether the configuration is correct.

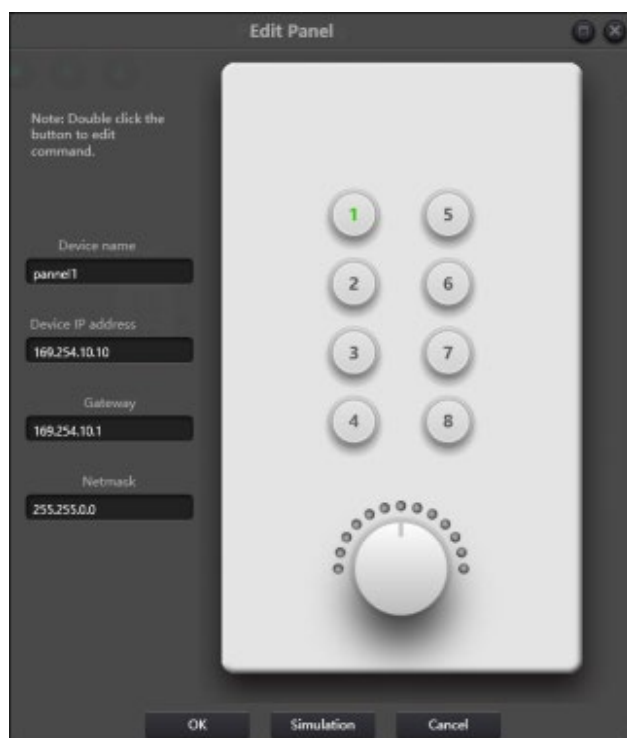

Instructions for panel operation indicators

1. Key indicator stays on, which indicates the key is configured with mute function.
2. Key indicator keeps flashing, which indicate the key is configured with gain function. The configured knob also uses and adjusts gain of the channel. 13 indicators around the knob indicate gains. They are on or off with gain size. All 13 indicators off indicates gain of -72dB while all on indicates gain of 12dB.
3. A sudden flash happens when pressing the key indicator indicates the key is configured with preset or command function.

Command function: The command data come from central control command. Please refer to section 5.



3.5.6 Dante Setting

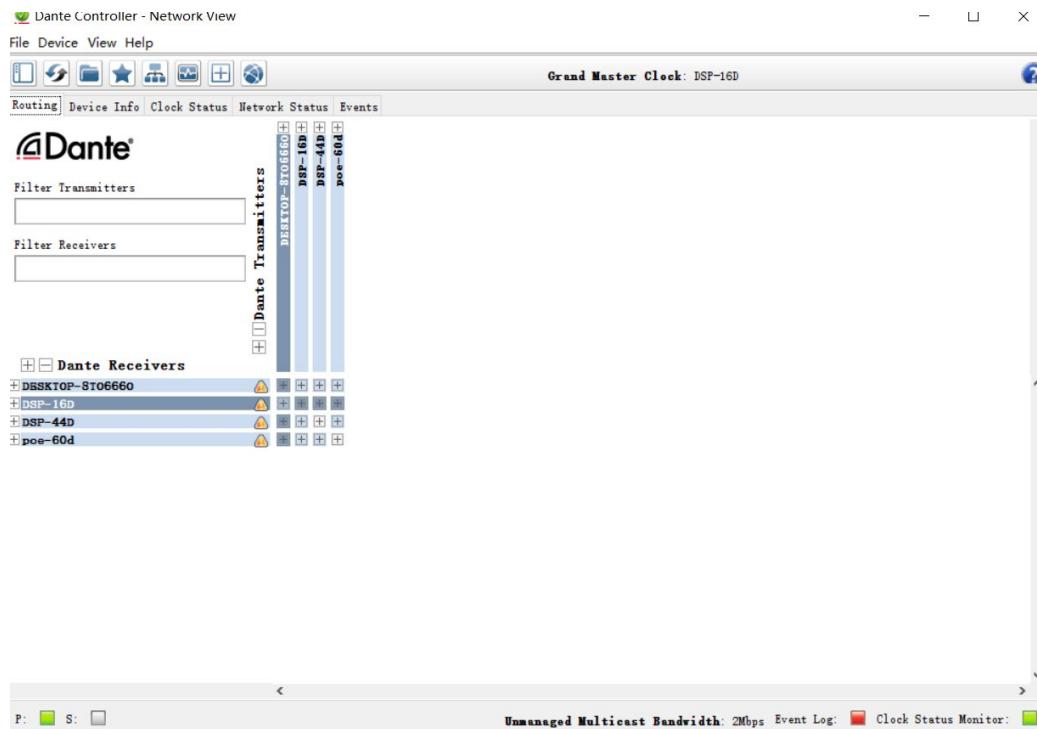

Note: Before Dante setting, please check whether the computer network card has been inserted into Dante network. If it is needed to set up a device lock or to check the signal indicators of Ultimo, virtual soundcard and other devices, please use DanteController. On this software interface, you can only check the signal indicator of Brooklyn.

Dante routing setting interface is similar to that of DanteController. It provides routing, channel information, network setting and other information. Dante device's receiving channels are displayed

on the left part of the device, while Dante device's sending channels are displayed on the right part of the device.



On the routing interface, the small boxes at the intersection of sending and receiving channels indicate that routing relationship can be created. Green icon  will appear at the intersection of matrix after single click. Users may see a grey icon  for a very short time period at the very beginning, which indicates that routing is in process.



Warning icon  or error icon  will appear if there is a routing problem. If several devices are subscribed at the same time, yellow icon  may appear temporarily.



Note: Route and locked devices can't be created, but existed route can be deleted or replaced.

Cancel Audio Subscriptions

Users may click subscribed intersections to cancel audio subscriptions. Subscribing icons will be removed and restore original small boxes.

Subscription Status

	Processing	Subscription is in processing
	Subscribed	Connection established
	Warning	Subscription is not processed normally because sending device is invisible on network

-  Error Send error, for example, no enough bandwidth on the network
-  Coming soon The device is processing subscription of other channels. In most cases, many channels are subscribed at once.

Users may view information like device' s IP address and version on device information.

Double click device name on routing interface to enter detailed settings of the device as shown in below figure.

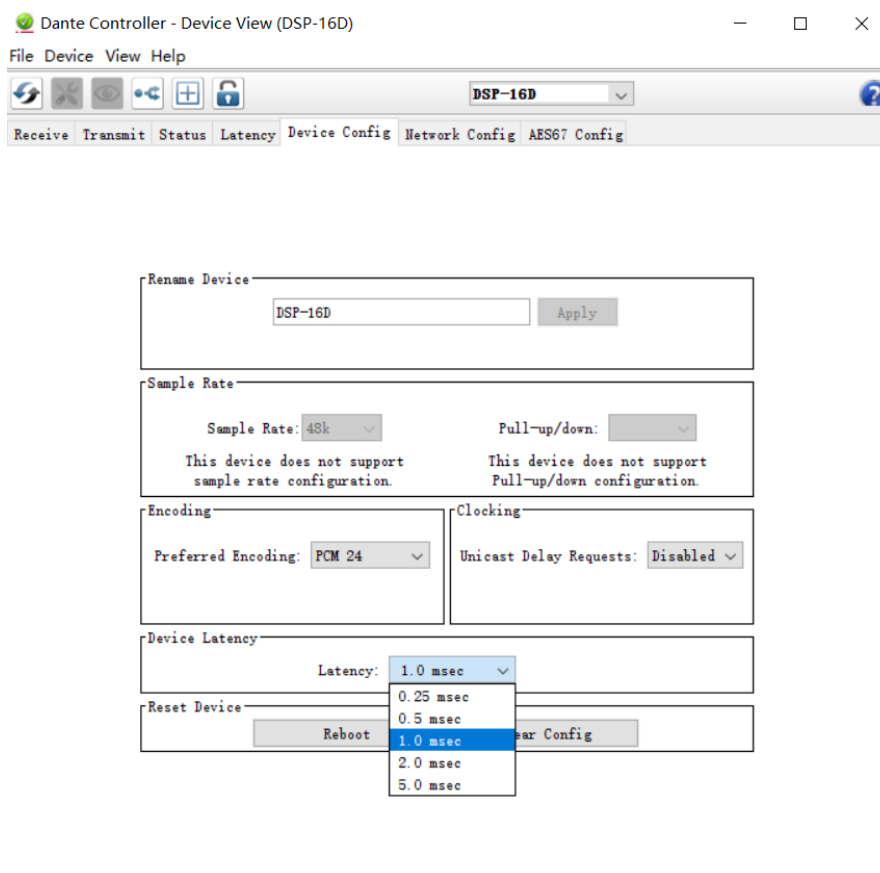

Channel names can be modified on sending and receiving labels. Channel naming rules are as follows:

The maximum total length for all DSP device names is 16 characters. The name length of devices supported by Dante is as more as 31 characters. Therefore, please ensure that name length of Dante device names and channel names is no more than 16 characters when routing by using the interface, or DSP Controller will cut the process off, which will result in incorrect subscription.

Names are case-insensitive. "Guitar" and "guitar" are the same name.

Valid characters include A-Z, a-z, 0-9 and '-' .

Device names can't start or end with '-' .

Device names shall also be unique on network.

Any characters can be used for naming sending channel labels, except '=', '.' and '@'.

Sending channel labels must be unique in the device.

Receiving channel naming has the same rules with sending channels.

Device Configuration:

Device configuration refers to device name modification, audio sample rate and delay. Device names must be modified follow device name modification rules. Delay needs to be emphasized. In Dante network, compensation is needed for various delays at receiving end. There is device setting delay (the interface delay) at each receiving end. The delay refers to time difference between samples received at receiving end and broadcasted. The default delay for Dante device is 1ms, which is enough for large-scale networks.

However, automatic negotiation will be carried out at sending and receiving ends when establishing connections, which ensures delay time is enough to prevent packet loss.

For example, Ultimo devices support minimum 1ms delay. If the delay for a faster device like PCIe card is set at 0.25s and the device is establishing connection with an Ultimo device, then the delay of subscription will be 1ms which is the minimum delay supported by subscriptions. If minimum delay possibly reaches 1s in megabyte network, then subscription error may occurred when transmitting in the condition that delay time no more than 1s.

Network Configuration:

Network configuration refers to network IP address, mask and gateway settings. Brooklyn supports redundancy mode and exchange mode settings.

Redundancy Mode

Many Dante devices have two network ports named "Primary" and "Secondary". "Primary" port connects physical network. If "Secondary" port has been used, then "Secondary" port shall connect another physical network. "Secondary" port can't communicate with "Primary" port.

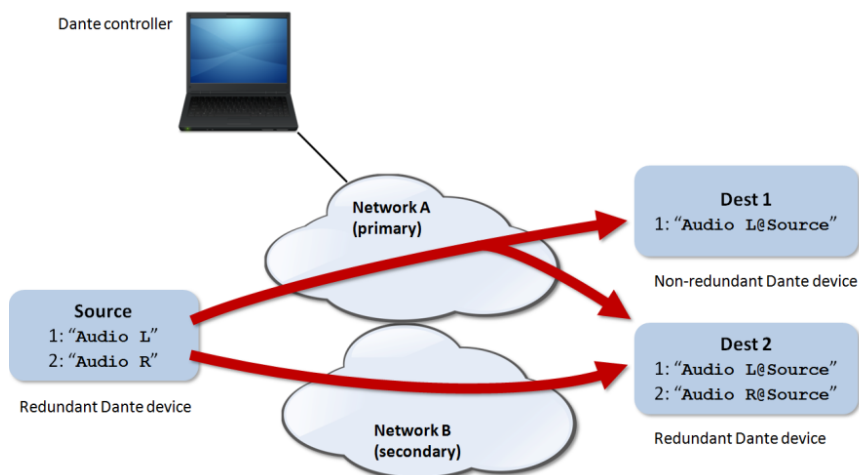

Multicast Stream:

What is stream? Dante audio routing automatically creates streams. A stream moves audio data from several channels from receiving ends to one or more receiving ends. Unicast streams are given to single receiving devices while multicast streams are given to multiple receiving devices. Multicast streams may be created or configured manually through the interface, but it uses network bandwidth whether there is receiving device or not. Meanwhile, it doesn't need extra bandwidth when more receiving ends are added.

As shown in the figure, select multicast stream label page, check device channel, click create, and then created multicast stream will display in the right list of the interface. It can also be deleted when users don't need it. A stream mostly include four channels by default. If more than four channels are checked, they will be divided to several streams automatically.

3.5.7 Help Menu

(1) Central command

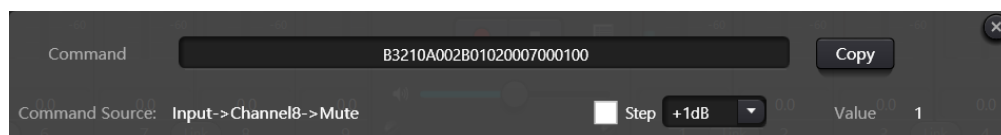

Open central control command window and click parameters to be controlled on interface, then the window will display current command immediately. Copy the command and then use UDP or RS232 to send the command to devices.

(2) Device upgrade

Device upgrade can be carried out through UDP. Connect the device, click setting-help-device upgrade. A file choice box will be popped up at this point, and then choose processor upgrade file (*.bin).

(3) About

Display version number, tech support contact information and copyright info., etc.

4. Dante Audio

4.1 Dante Overview

Dante technology launched by Audinate provides high performance digital media network to meet professional on-spot sound amplification, audio/video device installation and high sound quality and high performance requirements of broadcasting and recording systems.

Dante aims to fully develop performance of nowadays and future network devices. It may provide media transmission mechanism which can eliminate design limit of many traditional audio network. Dante makes it easier to create a steady and flexible digital audio network but meanwhile its performance is almost not limited. Dante network can be designed with a network speed mixing Gbps and 100Mbps as well as supports audios with different sampling rate and depth, and even allows network area design with different delays.

Dante is based on internet protocol, not only Ethernet. Dante uses standard IP through Ethernet, so it may run on cheap, existing computer network hardware. Meanwhile, by virtues of standard QoS, Dante may share installed network with other data and computer flow.

Dante provides sample accurate synchronization as well as lower delay required by professional audio. Dante network center is independent of similar synchronized audios and allows complete synchronous broadcasting through different audio channels, devices and networks and even among several switch hop counts.

Dante makes network a real plug-and-play process and allows automated device search and configuration. Compatible devices of Dante will automatically set their own network configuration and notify themselves and channels on network. It simplifies complex and error-prone setup assembly

programs and replace "magic numbers". Network devices and their input and output signals can be renamed to make them easier to be understood.

Dante is not limited to allow audio channel configuration and transmission. It also provides mechanism through its IP network to send or receive control and surveillance information, including the unique information of the device and controls appointed and developed by specific device manufacturers. Relying on its solid foundation and existing and evolving network standard, Dante can provide technology with proactive level, otherwise, it cannot be used in other types of digital audio transmission. From the beginning, Dante was designed for gigabit network. Moreover, Dante existing today has included the emerging AVB network standard. The continuous evolution of its network technology is an inseparable part of Dante's development.

Dante technology can be used for hardware and software to be installed and APIs referring to design and development. For more details, please visit Audinate website www.audinate.com.

Features:

Based on current IP-based network technologies including IEEE 802.3 and UDP/IP.

Use existing Ethernet hardware.

Use standard VoIP (IP voice technology) type QoS (quality of services) to integrate existing networks.

Integrate Ethernet network speed, and improve it from 100Mbit to 1Gb.

DSP' s digital audio frequency is 24 bits and its sampling rate is 48kHz. Dante itself may deeply integrate sampling rate and depth on the same network at the same time.

Dante of DSP devices supports network delay as low as 0.25 millisecond.

For device search, Plug and Play operation of ER. Automatic configuration.

Label-based routing. Renamable data stream.

The channel number of Dante included in the DSP processor is determined according to the type of device purchased. There are many versions including 8x8 and 16x16.

Use [Virtual Sound Card](#) software downloaded from Audinate to connect PC or Mac to Dante network directly.

4.2 Dante Requirements

CAT6 cables are used for all inner connections of Dante.

If flow control is conducted in the same network, then 30% of available broadband shall be reserved. When using the reservation method, a 100Mbit link may process channels as more as 48x48. A 1Gbps link may process channels as more as 512x512 when sampling rate is 48kHz.

Daisy chain and uplink shall be Gbps.

Repeater not supported.

Commercial-type managed switches shall be used when over 10 local units or units over 100 meters away connect. Switches must support following functions.

1. QoS with four queues.
2. DSCP with strict priority.

4.3 Dante Network Design

There are two network designs can be used for typical Dante network topology.

10 or less non-redundant units

For systems configured maximum 10 non-redundant units, please connect your pc to Ethernet port, connect remaining Ethernet ports with daisy chains, and then connect Dante ports with same daisy chains without specially using Dante switch or configuration. All units shall run under switched port mode.



More than 10 units or their distance between is over 100 meters

For systems equipped with more than 10 units or their distance is over 100 meters, please connect your pc or Ethernet ports on all units to one Ethernet switch and the Dante main port to the second Ethernet switch. All units shall run under switch port mode.

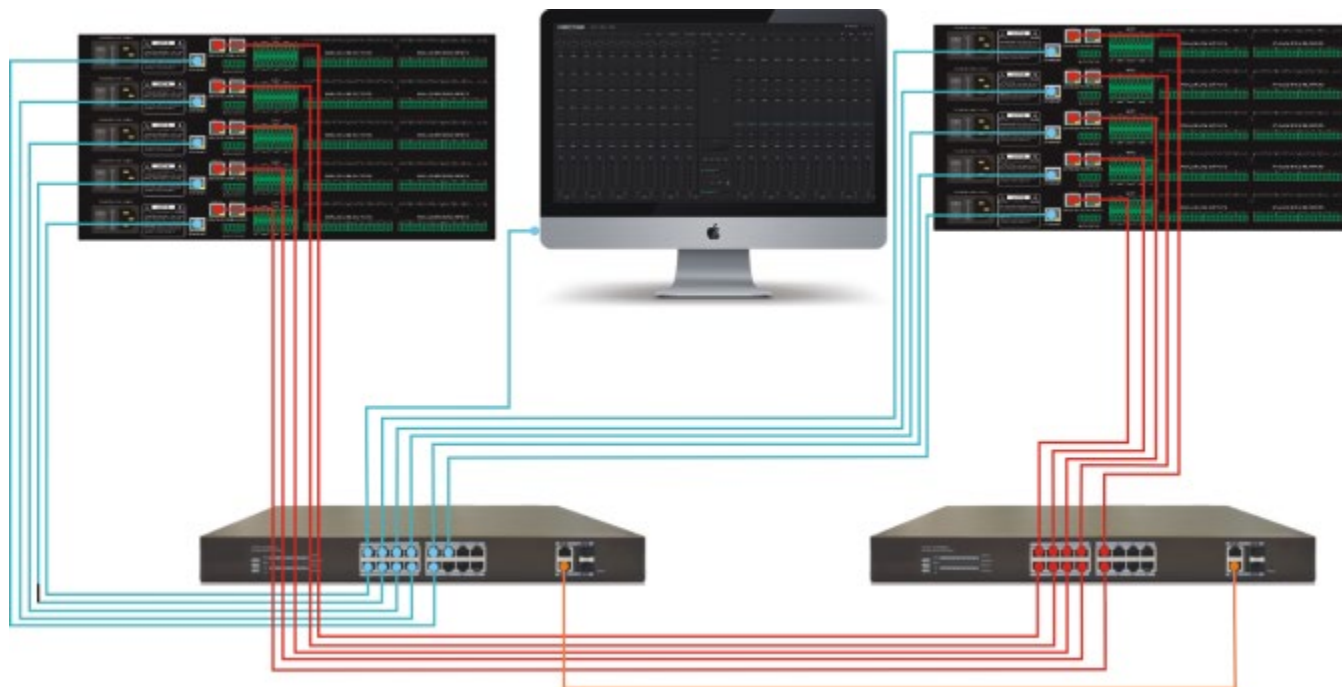

Delay

Dante network delay can be set through Dante Flow Manager on toolbar.

Network delay will increase as the number of switch increase. It's best to have less than 2 switches so as to realize a minimum delay. The system allows to use as more as ten switches, but delay will be increased accordingly. Maximum actual delay value must be always used. Delay is not decisive in many installations, for example, when sending audio to acoustic isolation chamber. In many cases, the highest delay can be selected to reduce the overall network traffic and minimize audio output decline on overload network. If low delay is the key, then numerical values consistent with the quantity of switches of the whole network shall be selected. If these two units are connected with daisy chain or single gigabit switch, then the delay of 0.25mS is normally safe. Otherwise, the delay of 0.5 or 1.0mS can be selected according to your network topology.

In Dante, network delay changes may gain compensation at user receiving ends. Each receiver has a Rx delay setting which is also in Dante settings of device information in DSP Controller. The setting limits delays between timestamps of incoming audio samples and sample broadcasting time.

The default delay for most Dante devices is 1Ms, which is enough for a large-scale network. The network consists of a gigabit network core (the hop count between switches is up to 10 times) and

100M links connected to Dante devices. Smaller gigabit networks may use delay with lower value (as low as 200 microseconds).

Note: Dante delay refers to system-level network delay setting, which means there are no extra delays or differences among subsequent all switch hops, such as non-additional delays. As long as (system-level network) delay settings have long enough time to go through the entire network path, data packets may reach the end of chains before buffer ending. Then Dante uses its clock calibration mechanism (PTP) to calibrate output accurately. Users may compare self-clocking between any two Dante units. Their delays are all within 100Ns or less than 1% during sampling period (up to 10 units have been proved). Therefore, multi-point output on daisy chains will align with samples. Each output has a specific delay from each output.

Note 2: Dante' s actual delays are intervals of three sampling times or 0.06mS longer than displayed time set by Dante delays of Composer, which is caused by DSP sampling butters and inevitable.

4.4 Dante Modes

When Dante devices are still in exchange mode, issues like modes can' t be changed or audio loss may occur if cables are used to connect devices and use them for redundancy mode. When devices switch from redundancy mode to exchange mode, please use following steps and vice versa.

1. When Dante devices are in exchange mode instead of redundancy mode, please connect their network. In other words, in condition that direct connection between external switches or two devices, then users only connect it to main socket. In condition that there is no external switch and more than two devices are needed, then connect main socket to the secondary port of next device with daisy chain. Do not insert the last device to the first device to avoid circulation created between them.
2. Enter Setting ->Dante Setting -> NetworkConfig in DSP Controller. Properly select redundant networks or switch ports.
4. Turn off system power
5. Connect Dante network to new modes depending on the circumstances. If switching to redundancy mode, then users now may connect main socket and secondary socket between two devices or single switch.
6. Turn on system power
7. Complete mode changes.

4.5 Dante Controller

Dante Controller is a software application provided by Audinate, allowing user to configure or send audios by routing in Dante network. It may be used to run Windows XP, Vista and Windows7 in pcs and OSX10.5 and 10.6 in Apple Mac. Once users install Dante Controller in pcs and connect it with Dante network, they may use Dante Controller to conduct following things.

View all Dante compatible audio devices and their network channels;

View clock and network settings of Dante compatible devices;

Send audios by routing on these devices and view current audio routing status;

Change labels of audio channels from numbers to suitable names;

Customize receiving delay (delay before broadcasting);

Save audio routing preset;

Apply saved preset;

View and set configuration options of each device, including:

1. Change device name;
2. Change sampling rate and clock settings;
3. View detailed network information;
4. Introduce a device web page to upgrade firmware and license information (where there is support).

Please visit Audinate website to download Dante Controller or get help.

4.6 Dante Virtual Soundcard

Dante Virtual Soundcard is an application software that can be purchased from Audinate. It may change customer' s pc or Mac to devices compatible with Dante. Standard Ethernet can be used to transmit or receive Dante audios, but require no additional hardware. The latest version uses standard Core Audio ((Mac OS X) of Dante Virtual Soundcard or ASIO (Windows) audio ports of Steinberg can be used for application of any audio.

Once users install Dante Virtual Soundcard on a pc or Mac and connect it to Dante network, users may

View and change existing audio sampling rate;

Customize receiving delay (receiving devices shall use delays before audio broadcasting);

View and set Ethernet ports of computers and view details of network ports;

Startup and shut off Dante Virtual Soundcard;

Select available audio channel numbers on Dante Virtual Soundcard.

For Windows system, users may

View and set specific parameters of ASIO.

Note: Users must install Dante Controller on pcs or Macs in Dante network to control audios and sending them by routing. It can be installed on the same computer with Dante Virtual Soundcard.

Please visit Audinate website to download Dante Virtual Soundcard or get help.

5. Control

5.1 External Control Programmer

External control programmer supports UDP and RS232 and controls protocols covering all controls parameters of processor, including parameter controls, parameter acquisition and preset calling.

When UDP controls are used, the default port is 50000. Ports can be set in “Device Setting” via upper computer software.

When using RS232 controls are used, the default baud rate is 115200, digit bits is 8, and stop bit is 1, no parity bit. Similarly, they can be set in “Device Setting” . **The interval between messages shall keep more than 100mS for RS232 sending.**

If central control needs reply, please turn on central control reply switch in “Device Setting” .

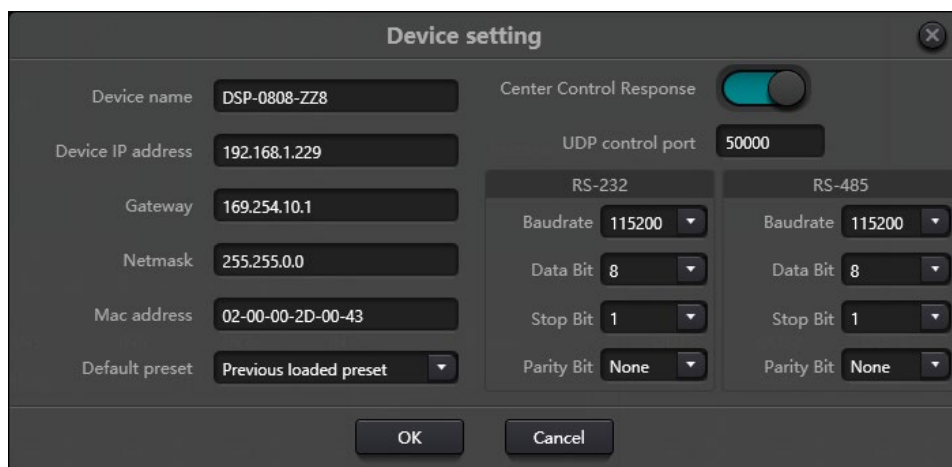

5.2 Control Protocol

Because of historical reasons, the latest control protocol adopts variable-length and is fully compatible with old fixed-length control protocols. In protocols, the fourth byte is used to distinguish versions. 0- indicates V1 version (previous versions) and 1- indicates V2 version (current protocol version).

The difference between V1 and V2 is V1 may control all processing module parameters, but one command can only control one parameter. If a parameter is needed to control continuous multiple channels, then V2 version shall be used. In other words, in condition that users need to press one key on key panel to trigger GPIO output high-/low-level of devices, or send a command via RS232/RS485, then V2 version will be the best choice.

Software coding rules (total 12 bytes)

byte1	byte2	byte3	byte4	byte5~132
0xb3	Message Type	Length	Version No.	Data

V1:

Information types (byte2): There are three information types including 0x21 (parameter controls), 0x22 (parameter acquisition) and 0x13 (scenario switch).

Length (byte3): invalid.

0x21 (parameter control):

At this point, Databyte5~12 are respectively

byte 5~6	byte 7~8	byte 9~10	byte 11~12
Module ID	Parameter Type	Parameter 1	Parameter 2

Please refer to Appendix A to get the distribution of **Module ID** (byte5~6).

Please refer to Appendix B for **Parameter types** (byte7~8).

When **Parameter 1** (byte9~10) has only one parameter, then only parameter 1 is valid, such as control compressor switch.

Parameter 2 (byte11~12) only valid when there are two parameters, such as control output channel 1 mute. Parameter value 1 shall be filled in input channel number from 0. Parameter value 2 shall be filled in 1 (mute).

Exception: Matrix routing has three parameters. The first one is input channel number, the second one is output channel number, and the third one is routing switch. At this point, byte9 of parameter value 1 shall be filled in input channel numbers, byte 10 shall be filled in output channel number, and parameter 2 shall be filled in routing switch.

0x22 (Parameter Acquisition):

Parameter acquisition rules are the same with parameter controls. The difference between them is values acquired shall be filled in parameter 1 and parameter 2.

0x13 (Scenario Switch):

Users only need to fill scenario numbers (0~15) in byte5 and 0 in byte6~12.

Note: Central control command of V1 version can acquire code through software menu bar of PC. For customized development, please use this protocol rule.

V2:

Message types (byte2): There are three message types (byte2) including 0x21 (parameter controls) , 0x22 (parameter acquisition) , 0x13 (scenario switch) , 0x74 (other controls) and 0x6e (Dante routing) .

Length (byte3): Fill in corresponding data section length based on information type. The length can be longer when actual sending is carried out. Total data volume can be got through adding 4 byte header information to data length.

1. Parameter Control (0x21)

At this point, the formats of data section are as follows.

byte5	byte6	byte7	byte8	byte9~72
Input/Output	Start Channel	End Channel	Parameter Type	Parameter Value

byte5: It indicate control input or output channel, 0x2- input channels and 0x1-output channels

byte6-7: They indicate start and end channel numbers. Channel numbers start from 0.

byte8: This kind of parameter is the same with V1 version. Please refer to Appendix B.

byte9-40: Fill in parameter values of start to end channels. It shall be filled in from the ninth byte. Each parameter value shall take two bytes.

2. Parameter Acquisition (0x22)

Data section format is the same with parameter controls. Parameter values may not be filled in. acquired parameters will be filled in this position.

3. Scenario Switch (0x13)

byte5: Fill in scenario numbers (0-15).

byte6-8: Fill in 0.

4. Other Controls (0x74)

Other controls include but not limited to GPIO, RS232, RS485 and central control replies. The protocol formats are as follows.

GPIO:

byte5	byte6	byte7	byte8	byte9	byte10	byte11	byte12
Control Type	Data Length	Reserved	Reserved	GPIO Direction	Start GPIO	End GPIO	Value

The controlling type for byte5 is 1.

The data length of byte6 is fixed as four bytes.

Byte9 GPIO direction, set input or output. Value 0 indicates input, and value 1 indicates output.

Byte10-11 start GPIO and end GPIO. DSP devices totally have eight GPIOs, which are indicated with number 0-7.

Byte12 is determined according to byte9GPIO direction. The field shall be filled in high (1) /low (0) level for output settings. The field is a return field to read GPIO level value on devices for input settings.

RS232/RS485:

byte5	byte6	byte7	byte8	byte9-132
Control Type	Data Length	Reserved	Reserved	Data

Byte5 is 2 when controlling type RS232, and 3 for RS485.

The data length of byte6 refers to data length that shall be sent via RS232/485 currently.

Byte9-132 shall be filled in data sent by RS232/485.

Central control replies:

byte5	byte6	byte7	byte8	byte9
Control Type	Data Length	Reserved	Reserved	Reply Switch

Byte5 controlling type is 4.

The data length of byte6 is 1.

When byte9 is 1, it means turning on central control replies switch; and 0 means turning off replies.

5. Dante Routing (0x6e)

Data section formats are:

byte5	byte6	byte7	byte8	byte9-24	byte25-40
Dante Channel No.	Routing Switch	Reserved	Reserved	Subscribed channel name	Subscribed device name

Byte5 Dante channel numbers. The difference is, Dante channel numbers start from 1.

Byte6 Dante channel, subscribe/cancel subscription of appointed channels of Dante devices indicated with byte25-49. The appointed channels are indicated with byte9-24 channel names.

5.3 Serial Port-to-UDP (RS232 To UDP)

DSP devices support RS232 translating into UDP. The protocol formats are as follows.

4bytes prefix	4bytes	2bytes	1byte	1byte	128bytes
UDP:	IP Address	Port	Data Length	Reserved	Data

After receiving the protocol format data packet, RS232 send data in the protocol to appointed IP addresses and devices at ports.

For example, when sending data " HELLO DSP to device port 50000 of device " 192.168.10.22" , the protocol commands are as follows.

4 bytes prefix	4 bytes	2 bytes	1 byte	1 byte	128 bytes
0x3a504455 (' :PDU')	0x1610A8C0	0xC350	0x09	0x00	" HELLO DSP"

Application scenario: The function can be applied in scenarios when many central control hosts have no network port. As shown in the figure, central control hosts translate network commands through serial ports to control any network device.

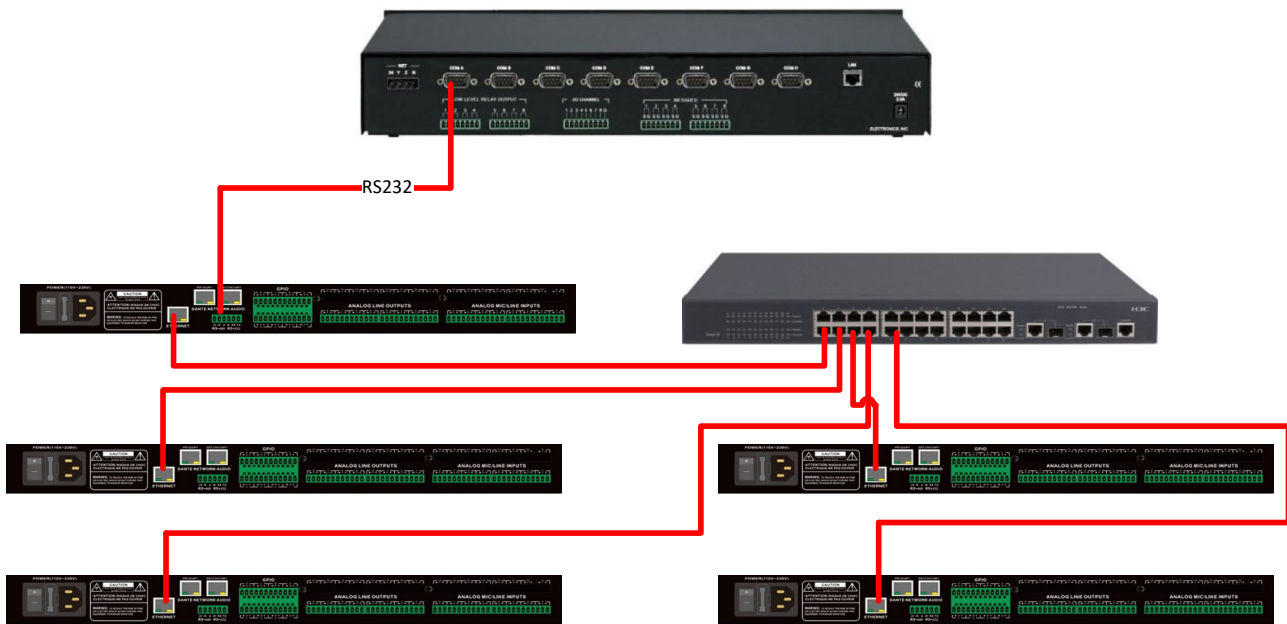

5.4 ASCII control command

Preface:

Concentrate:

1, because the starting bit of the channel is 0, it can be understood that the 0-3 channel corresponds to the IN1-4 software display channel, and 0-3 is only for example. The actual number of channels shall prevail the device model.

2. In the function on/off settings, 1 is open and 0 is off; For example, `set:output#mute#0-3#1`. The last 1 stands for "turn on mute".

5.4.1 Input volume control and acquisition

```
set:input#gain#0-3#1
```

(Setting: Enter #Gain #Channel Number # to 1dB)

get:input#gain#0-3 --> get:input#gain#0-3#1#1#1#1

(Get: Input #Gain#Channel Number) Return Information Example: get:input#gain#0-3#1#1#1#1#1(Input 1-4 channel volume is 1/1/1/1 in turn)

5.4.2 Output volume control and acquisition

set:output#gain#0-3#1

get:output#gain#0-3 --> get:output#gain#0-3#1#1#1#1

5.4.3 Phantom power supply control and acquisition

set:input#phant#0-3#1

get:input#phant#0-3 --> get:input#phant#0-3#1#1#1#1

5.4.4 Input Mute Control and Acquisition

set:input#mute#0-3#1

get:input#mute#0-3 --> get:input#mute#0-3#1#1#1#1

5.4.5 Output mute control and acquisition

set:output#mute#0-3#1

get:output#mute#0-3 -> get:output#mute#0-3#1#1#1#1

5.4.6 Control and acquisition of sensitivity

set:input#sens#0-3#1 (for 3db, for second gear)

get:input#sens#0-3 -> get:input#sens#0-3#1#1#1#1

5.4.7 Control acquisition of matrices: multiple inputs control a single output, and one input controls multiple outputs

set:mixer#switch#0#0-3#1 (set input 1 to output 1 and 4 routes to open)

set:mixer#switch#0-3#0#1 (set input 1 to 4 to output 1 route open)

set:mixer#gain#0-3#0#1 (set input 1 to 4 to output 1 route gain 1db)

get:mixer#switch#0-3#0(0-3:input,0:output) -> get:mixer#switch#0-3#0#1#0#1#1

5.4.8 Invocation and Saving of Scenarios

scene: toggle #3 (scene call, pc is displayed as scene 4)

scene:save#3 (save scene)

5.4.9 Input level acquisition

get:input#level#0-3 -> get:input#level#0-3 #-105.4#-102.5#-105.2#-104.8(dbfs)

5.4.10 Output level acquisition

get:output#level#0-3 -> get:output#level#0-3#-56.0#-40.8#-43.6#-46.4

5.4.11 System Mute Control and Acquisition

set:sysctl#mute#1 (on system mute)

get:sysctl#mute -> get:sysctl#mute#1

5.4.12 Settings and getting the channel name of the input and output

set:input#name#0#1

get:input#name#0-3 -> get:input#name#0-3#IN1#IN2#IN3#IN4

5.4.13 Input and output inverting control and acquisition

set:input#phase#0-3#1

set:output#phase#0-3#1

get:input#phase#0-3 -> get:input#phase#0-3#1#1#1#1

get:output#phase#0-3 -> get:output#phase#0-3#1#1#1#1

5.4.14 Input and output step control and acquisition

set:input#step#0-3#10

set:output#step#0-3#10

5.4.15 Input and output link control and acquisition

set:input#link#0-3#1

set:output#link#0-3#1

get:input#link#0-3 -> get:input#link#0-3#1#1#1#1

get:output#link#0-3 -> get:output#link#0-3#1#1#1#1

5.4.16 Control and acquisition of signal generators

set:input#type#0-3#1

get:input#type#0-3 -> get:input#type#0-3#1#1#1#1

5.4.17 Restore factory settings control

set:refactory

5.4.18 Scene Reset Control

set:rescene

5.4.19 Get the name of the scene that is set arbitrarily

set:scene#name#0-3#pre1 (PC only supports UTF-8 encoding, Chinese ANSI code will become garbled)

get:scene#name#0-3 (scene number: 0-15) -> get:scene#name#0-3#pre1#pre1#pre1#pre1#pre1

5.4.20 Module name:input,output|mixer

item 名:

(input)mute,gain,sens,phant,type,freq,name,phase,step,link,level

(output)mute,gain,name,step,link,level

(mixer)switch,gain

(scene)toggle,save,name

(sysctl)mute

(rescene)

(refactory)

5.4.21 Format the instruction:

set: Module name #itemname #Start Channel-End Channel # Parameter value

For example

set:input#mute#0-3#0/1

5.4.22 Get the instruction format

get: Module name #itemname #Start Channel- End Channel

For example

get:input#mute#0-3

6. FAQs

1. How to restore factory setting?

Connect it to computer through RS232 and run serial port software (SecureCRT is recommended to use). The default baud rate of series ports is 115200, 8 data bits, no parity check, one stop bit. After connecting SecureCRT to serial ports, long press to enter at terminal interface to reboot the computer and enter bootloader boot dialog box as shown in the figure.

Command explanation:

del config: delete configuration information, such as network configurations like IP address. The device restores to default IP 169.254.20.227 after deleting.

del secens: delete preset. All 16 presets of DSP devices restore to default values.

del all: delete all sections except the program.

Note: There may be no echo after the installation of some SecureCRTs. Please check " Local echo" by going to Options->Session Options, as shown in the figure.

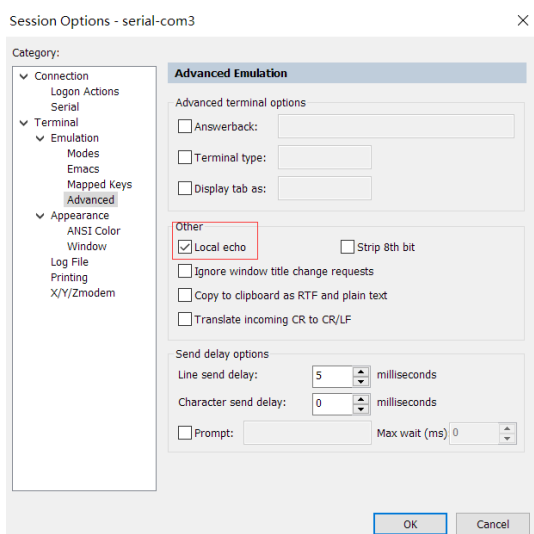

Appendix A: Module ID Distribution

Module Name	ID	Module Name	ID
Input source	299	Output Channel 1-32 High & Low Pass	167~198
Input Channel 1-32 Expander	1~32	Output Channel 1-32 Equalizer	199~230
Input Channel 1-32 Compressor	33~64	Output Channel 1-32 Delayer	231~262
Input Channel 1-32 Auto Gain	65~95	Output Channel 1-32 Limiter	263~294
Input Channel 1-32 Equalizer	97~128		
Input Channel 1-32 Feedback Inhibition	129~160		
AutoMixer	161	Echo Canceller	162
Echo Cancellation	163	Noise Suppressor	164
Noise Suppression	165		
Mixer	166		
Output	295		
System Control	296		

Appendix B: Module Parameter Types (1)

Module Name	Parameter Type	Description	Module Name	Parameter Type	Description
Input Source	0x1	Gain	Output	0x10	Gain Compensation
	0x2	Mute		0x11	Link
	0x3	Sensitivity		0x12	Channel Level
	0x4	Phantom Power Switch		0x1	Gain
	0x5	Signal Generator Type		0x2	Mute
	0x6	Signal Generator Frequency		0x3	Channel Name
	0x7	Sine Wave Gain Size		0x4	Invert
	0x8	Channel Name		0x5	Sensitivity
	0x9	Invert		0x6	Gain Compensation
	0x10	Gain Compensation		0x7	Link
	0x11	Link		0x8	Channel Level
	Delayer	0x12		Channel Level	Expander
0x1		Bypass Switch	0x2	Threshold	
0x2		Millisecond	0x3	Ratio	

	0x3	Microsecond		0x4	Setup Time
Equalizer	0x1	Total Equalizer Switch		0x5	Release Time
	0x2	Child Segment Switch	Compressor	0x1	Compressor Switch
	0x3	Frequency		0x2	Compressor Threshold
	0x4	Gain		0x3	Compressor Ratio
	0x5	Q Value		0x4	Setup Time
	0x6	Type		0x5	Recovery Time
				0x6	Gain Compensation

Appendix B: Module Parameter Types (2)

Module Name	Parameter Type	Description	Module Name	Parameter Type	Description
Mixer	0x1	Mixer Switch	Feedback Inhibition	0x1	Switch
	0x2	Mixer Gain		0x2	Feedback Point Frequency
High & Low Pass	0x1	High Pass Switch	0x3	Feedback Point Gain	
	0x2	High Pass Type	0x6	Preset	
	0x3	High Pass Slope	0x7	Clear	
	0x4	High Pass Frequency	0x8	Panic Threshold	
	0x5	High Pass Gain	0x9	Feedback	
Auto Mix	0x11	Low Pass Switch	Auto Gain	0x1	Switch
	0x12	Low Pass Type	0x2	Threshold	
	0x13	Low Pass Slope	0x3	Target Threshold	
	0x14	Low Pass Frequency	0x4	Ratio	
	0x15	Low Pass Gain	0x5	Setup Time	
Auto Mix	0x1	Total Mute	0x6	Release Time	
	0x2	Total Gain	Echo Cancellation	0x1	Echo Cancellation Switch
	0x3	Slope	0x2	Echo Cancellation Mode	

0x4	Response Time	Noise Suppression	0x1	Noise Suppression Switch
0x5	Channel Auto Switch		0x2	Noise Suppression Mode
0x6	Channel Mute	System Control	0x1	System Mute
0x7	Channel Gain		0x2	System Gain
0x8	Priority			
0x9	Auto Mix Switch			